

Simply  
Good and Beautiful

# MATH

# 2

COURSE BOOK



# Table of Contents



<b>About the Course</b> .....	iv	Lesson 35: Expanded Form to the Hundreds .....	102
<b>Frequently Asked Questions</b> .....	v	Lesson 36: Inches, Feet, and Yards .....	105
<b>Unit 1</b> .....	1	Lesson 37: Commutative Property/Checking Addition with Subtraction .....	107
Lesson 1: Place Value to the Hundreds .....	2	Lesson 38: Adding Numbers with Three or More Digits .....	109
Lesson 2: Identifying and Writing Numbers to 1,000 .....	6	Lesson 39: Time: Part 5 .....	111
Lesson 3: Skip Counting by 50s .....	8	Lesson 40: Adding Dollars and Cents .....	113
Lesson 4: Spelling 13, 14, and 15 .....	11	Lesson 41: Time: Part 6 .....	116
Lesson 5: Counting Bills .....	14	Lesson 42: Time: Part 7 .....	119
Lesson 6: Doubles Addition to Sums of 18/Star Logic .....	16	Lesson 43: Fact Families .....	122
Lesson 7: Tally Marks/Working with Bills .....	20	Lesson 44: Spelling 16 to 19 .....	126
Lesson 8: Zero as a Placeholder/Adding 2 Two-Digit Numbers .....	22	Lesson 45: Measuring: Part 1 .....	130
Lesson 9: Subtraction Strategy #1 .....	25	Lesson 46: Measuring: Part 2 .....	132
Lesson 10: Subtraction Strategy #2 .....	27	Lesson 47: Time: Part 8 .....	135
Lesson 11: Counting by 25s .....	30	Lesson 48: Subtraction with Money .....	138
Lesson 12: Time: Part 1 .....	32	Lesson 49: Fractions: Part 1 .....	142
Lesson 13: Subtraction with Two-Digit Numbers .....	35	Lesson 50: Fractions: Part 2 .....	145
Lesson 14: Calendar Work: Part 1 .....	37	Lesson 51: Addition: Regrouping Ones and Tens .....	147
Lesson 15: Calendar Work: Part 2 .....	40	Lesson 52: Associative Property and Adding 3 One-Digit Numbers ..	150
Lesson 16: Doubles Addition Plus 1 .....	43	Lesson 53: Counting Dollars and Coins .....	152
Lesson 17: Time: Part 2 .....	46	Lesson 54: Time: Part 9 .....	154
Lesson 18: Adding Two-Digit Numbers with Regrouping .....	49	Lesson 55: Measuring: Part 3 .....	156
Lesson 19: Ordinal Positions 1 to 12 .....	51	Lesson 56: Time: Part 10 .....	159
Lesson 20: Greater Than, Less Than, Equal .....	53	Lesson 57: Rounding to the Nearest 10: Part 2 .....	162
Lesson 21: Doubles in Subtraction .....	55	Lesson 58: Thermometers .....	165
Lesson 22: Creating Repeating Patterns and Color Patterns .....	57	Lesson 59: Time: Part 11 .....	168
Lesson 23: Counting Coins: Part 1 .....	60	Lessons 60–61: Unit Assessment .....	170
Lesson 24: Dividing Groups of Coins in Half .....	63	<b>Unit 3</b> .....	178
Lesson 25: Time: Part 3 .....	66	Lesson 62: Counting and Writing in the Thousands .....	179
Lesson 26: Time: Review .....	70	Lesson 63: Subtraction with Regrouping: Part 1 .....	182
Lesson 27: Time: Part 4 .....	74	Lesson 64: Place Value to the Thousands .....	185
Lesson 28: Calendar Work: Part 3 .....	78	Lesson 65: Adding and Subtracting 10 and 100 in the Thousands ..	188
Lesson 29: Counting Coins: Part 2 .....	80	Lesson 66: Missing Numbers in Addition Problems .....	192
Lesson 30: Rounding to the Nearest 10: Part 1 .....	82	Lesson 67: Expanded Form to the Thousands .....	194
Lesson 31: Dozen, Half Dozen/One More and One Less .....	86	Lesson 68: Estimating with Subtraction .....	197
Lessons 32–33: Unit Assessment .....	89	Lesson 69: Money Practice .....	200
<b>Unit 2</b> .....	98	Lesson 70: Subtraction with Regrouping: Part 2 .....	202
Lesson 34: Add and Subtract 10 and 100 .....	99		





# Table of Contents

Lesson 71: Dividing into Groups . . . . .	206	Lesson 105: Vertical and Horizontal Lines and Angles . . . . .	306
Lesson 72: Dividing into Two Equal Groups with and without One Left Over . . . . .	208	Lesson 106: Symmetry . . . . .	309
Lesson 73: Rounding with Addition . . . . .	210	Lesson 107: Drawing Congruent Line Segments . . . . .	312
Lesson 74: Adding 3 Two-Digit Numbers . . . . .	212	Lesson 108: Congruent and Similar Shapes . . . . .	315
Lesson 75: Polygons . . . . .	216	Lesson 109: Geometric Solids . . . . .	318
Lesson 76: Fractions: Part 3 . . . . .	220	Lesson 110: Constructing and Deconstructing Geometric Shapes . . . . .	321
Lesson 77: Fractions: Part 4 . . . . .	223	Lesson 111: Identifying Transformations . . . . .	325
Lesson 78: Multiplication: Part 1 . . . . .	226	Lesson 112: Perimeter . . . . .	328
Lesson 79: Multiplication: Part 2 . . . . .	230	Lesson 113: Identifying Triangles . . . . .	331
Lesson 80: Weight: Part 1 . . . . .	233	Lesson 114: Area: Part 1 . . . . .	334
Lesson 81: Multiplication: Part 3 . . . . .	236	Lesson 115: Area: Part 2 . . . . .	337
Lesson 82: Weight: Part 2 . . . . .	238	Lesson 116: Subtraction: Making Change . . . . .	340
Lesson 83: Two-Step Story Problems: Part 1 . . . . .	242	Lesson 117: Coordinate Graphs . . . . .	343
Lesson 84: Weight: Part 3 . . . . .	245	Lesson 118: Mixed Review . . . . .	346
Lesson 85: Fractions: Part 5 . . . . .	247	Lessons 119–120: Course Assessment . . . . .	349
Lesson 86: Multiplication Story Problems . . . . .	250		
Lesson 87: Two-Step Story Problems: Part 2 . . . . .	252		
Lesson 88: Data: Creating a Venn Diagram . . . . .	256		
Lessons 89–90: Unit Assessment . . . . .	258		
<b>Unit 4</b> . . . . .	265		
Lesson 91: Tally Charts and Pictographs . . . . .	266		
Lesson 92: Tables and Bar Graphs . . . . .	269		
Lesson 93: Plotting and Interpreting Data . . . . .	272		
Lesson 94: Finding the Median . . . . .	275		
Lesson 95: Centimeters, Meters, and Kilometers . . . . .	278		
Lesson 96: Gallons, Quarts, Pints, and Cups . . . . .	281		
Lesson 97: Cups, Half Cups, Tablespoons, Teaspoons, and Half Teaspoons . . . . .	284		
Lesson 98: Comparing and Ordering Volumes in Liters and Milliliters . . . . .	286		
Lesson 99: Addition and Subtraction Measurement Problems . . . . .	288		
Lesson 100: Identifying Parts of a Set . . . . .	290		
Lesson 101: Fractions: Part 6 . . . . .	294		
Lesson 102: Identifying and Writing Mixed Numbers . . . . .	297		
Lesson 103: Representing a Given Fraction . . . . .	300		
Lesson 104: Quadrilaterals . . . . .	303		



# ABOUT THE COURSE

## Supplies Needed

- *Simply Good and Beautiful Math 2 Course Book*
- *Simply Good and Beautiful Math 2 Math Box*
- Pencil
- Crayons or colored pencils
- Whiteboard and dry-erase marker

The course book will not list when you need the math box or a whiteboard and

dry-erase marker, but you will use them in most lessons, so always have them on hand. Because the math box is organized into easy-to-access compartments, individual math box items needed are not listed at the beginning of the lessons.

## Course Organization

The course book serves as the teacher's guide and the course book.

The course has 120 lessons divided into four units. Each unit has an assessment at the end of the unit.

If you complete four lessons a week, you will finish in a normal school year and have about four weeks left over that can account for normal breaks, sickness, and vacations.

## Daily Lessons

- **Review Box**—You can choose to review these concepts at the beginning of each lesson, or you can skip them if the child has mastered the concepts.

- **Lesson**—Blue text is instructions to the parent or teacher. Black text is read to the child. Each lesson contains instruction and practice on a new concept.

- **Independent Review**—Each lesson includes one or more pages of review. The review pages can usually be done independently by the child after the instructions are explained to him or her. The concepts reviewed are from previous lessons. This means the child can complete the review page before the lesson, if needed, while you work with another child.

**Lesson 4** **SPELLING 13, 14, AND 15**

**Odd Numbers + Counting Backward**

- Have the child tell you what every odd number ends with. [1, 3, 5, 7, or 9]
- Have the child skip count by 50s from 50 to 300.
- Have the child count backward from 20 to 1.

**Read to the child:** Today we get to play a space game. You will need to know how to spell 13, 14, and 15, so first complete this spelling practice.

thirteen \_\_\_\_\_  
fourteen \_\_\_\_\_  
fifteen \_\_\_\_\_

**Planet Path Game:** Give the child the rocket from the math box. Read to the child: In this game you will try to visit all the planets on the page without getting stuck! You'll begin on Mars, so place your rocket on Mars. To move your rocket to another planet, you must first spell aloud the number on the planet. Mars has the number 13 on it, so you'll spell the number word for 13. If you spell the number word correctly, you can move your rocket 1 planet up, down, sideways, or diagonally. You're not allowed to skip planets or go back to planets that you've already visited. If you get stuck and can't move, place your rocket back on Mars and start again. (Please note that Pluto is a dwarf planet.)

**Planet Path Game**

**INDEPENDENT REVIEW**

Count by 50s to fill in the missing numbers.

50		150		250		350			
----	--	-----	--	-----	--	-----	--	--	--

Complete the addition problems by counting by 50s. If needed, use the chart above.

50 + 50 + 50 =     150 + 50 + 50 =

Complete the subtraction problems.

6	7	8
- 1	- 2	- 1

Draw a line from each doubles addition problem to the correct answer on a planet.

9 + 9 =    3 + 3 =

8 + 8 =

7 + 7 =

6 + 6 =    5 + 5 =

Write and complete the problem for the story.

Neptune has 14 moons. Mars has 2 moons.

How many moons do Neptune and Mars have total?

+  =



# Frequently Asked Questions

## How do I get started?

Gather the supplies needed. You are then ready to open to the first lesson and follow the instructions. You do not need to read the lessons before teaching them.

## How long are lessons?

For children right on level with the lessons, most lessons take 20–25 minutes.

- If the child takes longer than 20–25 minutes per lesson but is understanding and retaining the information, don't worry; complete as much of a lesson as the child's attention span allows each day. It is OK if this course takes longer than a school year to complete.
- If the child takes less than 20–25 minutes per lesson and is learning new things, we suggest not moving to Math 3 so that the child does not have holes in his or her math foundations. Rather, consider having the child do multiple lessons a day and move through the course quickly before starting Math 3.
- If the child takes less than 20–25 minutes per lesson and seems to already know all the information, consider having the child take the assessments in the course (see the Table of Contents) to see if the child can skip any units or the whole course.

Our thorough piloting program proved that most children in Grade 2 thrive with having math for 20–25 minutes a day, as this curriculum is carefully designed to maximize time and effectiveness. If you or the child feels more time is needed, consider doing two lessons a day.

## Is Math 2 a spiral or mastery program?

Math 2 is mainly a spiral curriculum, constantly reviewing concepts the child has learned to ensure he or she understands and retains the information.

## Do you include any specific doctrine?

No, the goal of our curriculum is not to teach doctrines specific to any particular Christian denomination but to teach general principles, such as honesty, hard work, and kindness. All Bible references in our curriculum use the King James Version.

## Is there an answer key?

Yes, you can find the answer key by clicking on the “FAQs and Extras” button from the Math 2 page on [goodandbeautiful.com](http://goodandbeautiful.com). The answer key is a free download.

You may also purchase a physical answer key under the “Individual Items” section of the Math 2 page at [goodandbeautiful.com](http://goodandbeautiful.com).



Lesson

4

SPELLING 13, 14, AND 15

Odd Numbers + Counting Backward

- Have the child tell you what every odd number ends with. [1, 3, 5, 7, or 9]
- Have the child skip count by 50s from 50 to 300.
- Have the child count backward from 20 to 1.

- **Read to the child:** Today, we get to play a space game. You will need to know how to spell 13, 14, and 15, so first complete this spelling practice.

thirteen

\_\_\_\_\_

-----

\_\_\_\_\_

fourteen

\_\_\_\_\_

-----

\_\_\_\_\_

fifteen

\_\_\_\_\_

-----

\_\_\_\_\_

- **Planet Path Game:** Take the rocket from the math box and give it to the child. **Read to the child:** In this game you will try to visit all the planets on the page without getting stuck! You'll begin on Mars, so place your rocket on Mars. To move your rocket to another planet, you must first spell aloud the number on the planet. Mars has the number 13 on it, so you'll spell the number word for 13. If you spell the number word correctly, you can move your rocket one planet up, down, sideways, or diagonally. You're not allowed to skip planets or go back to planets that you've already visited. If you get stuck and can't move, place your rocket back on Mars and start again. (Please note that Pluto is a dwarf planet.)

Planet Path Game

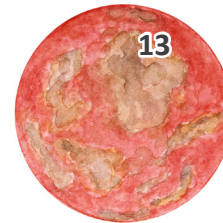

Mars



Earth



Venus

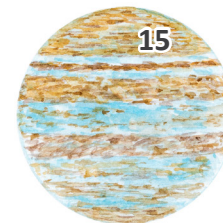

Jupiter



Saturn



Uranus



Pluto

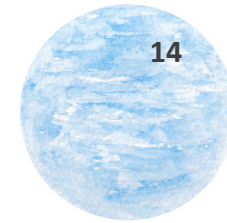

Neptune

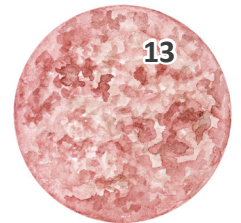

Mercury

- Have the child write the number word represented by the blocks.

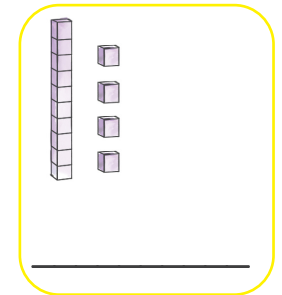
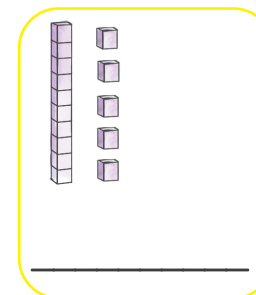
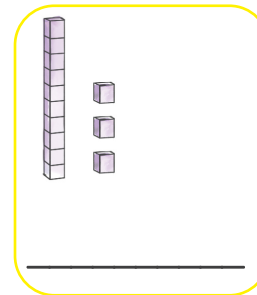

# INDEPENDENT REVIEW

Count by 50s to fill in the missing numbers.

50		150		250		350			
----	--	-----	--	-----	--	-----	--	--	--

Complete the addition problems by counting by 50s. If needed, use the chart above.

$$50 + 50 + 50 = \boxed{\phantom{000}}$$

$$150 + 50 + 50 = \boxed{\phantom{000}}$$

Complete the subtraction problems.

6	7	8
$- 1$	$- 2$	$- 1$
<hr/>	<hr/>	<hr/>

Draw a line from each doubles addition problem to the correct answer on a planet.

$9 + 9 =$	$3 + 3 =$
$8 + 8 =$	
$7 + 7 =$	
$6 + 6 =$	$5 + 5 =$

Write and complete the problem for the story.

Neptune has 14 moons. Mars has 2 moons.

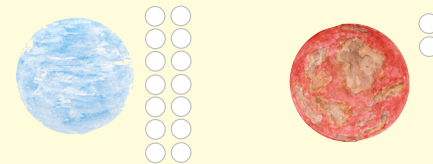

How many moons do Neptune and Mars have in total?

$$\boxed{\phantom{00}} + \boxed{\phantom{00}} = \boxed{\phantom{00}}$$



As of 2021, many unpiloted rovers or orbiters have visited the planets below. Complete the problem below each planet. The planet with the largest answer has been visited the most. (Note: The answers do not reflect the total number of rovers or orbiters that have visited each planet.)



Mercury

$$\begin{array}{r} 10 \\ - 8 \\ \hline \end{array}$$



Mars

$$\begin{array}{r} 3 \\ + 3 \\ \hline \end{array}$$

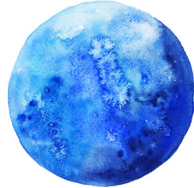

Neptune

$$\begin{array}{r} 8 \\ - 7 \\ \hline \end{array}$$

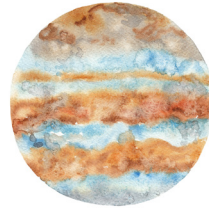

Jupiter

$$\begin{array}{r} 7 \\ - 3 \\ \hline \end{array}$$



Venus

$$\begin{array}{r} 1 \\ + 4 \\ \hline \end{array}$$



Saturn

$$\begin{array}{r} 9 \\ - 6 \\ \hline \end{array}$$

How many inches long is each toy rocket? Write the answers with number words (like "one" or "two," not "1" and "2") in the blue boxes.

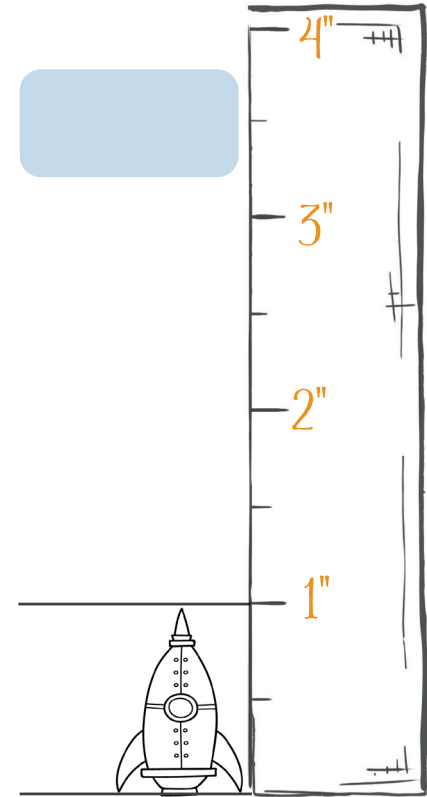
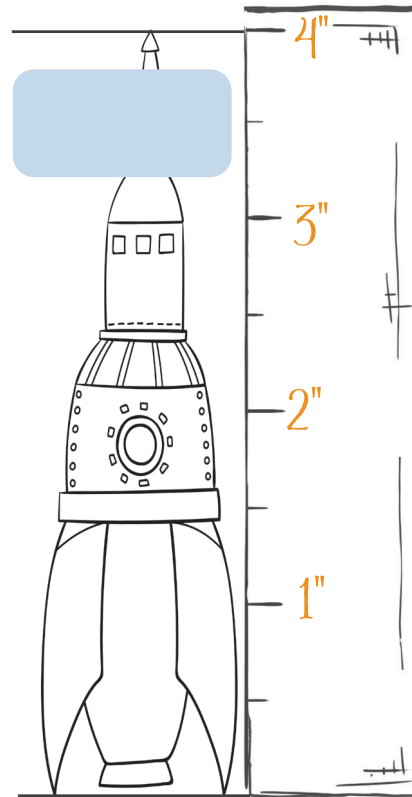
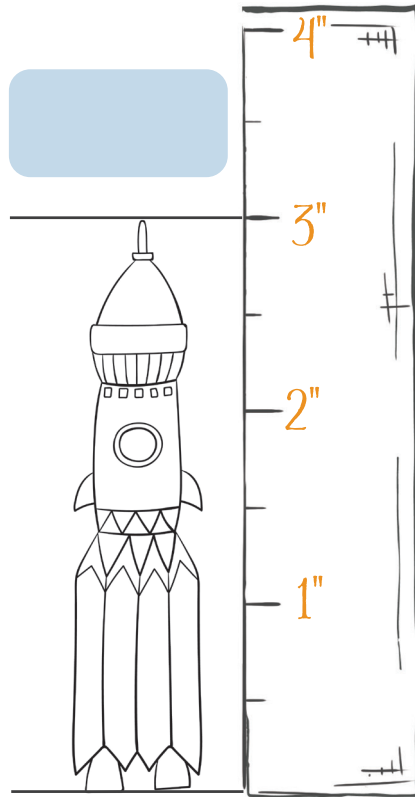
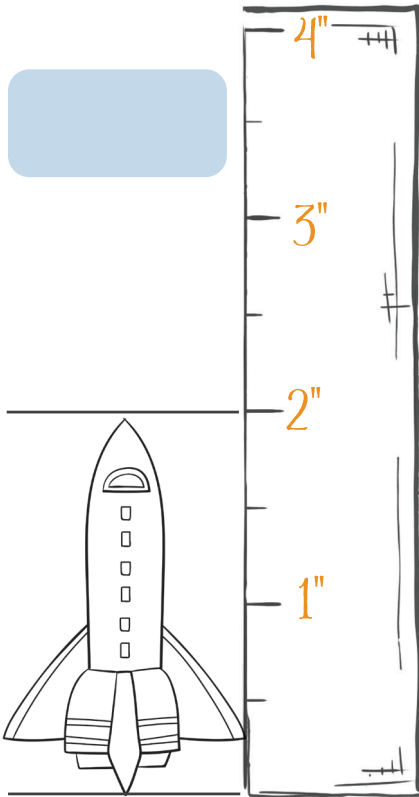

Lesson  
**6**

## DOUBLES ADDITION TO SUMS OF 18/STAR LOGIC

### Odd Numbers + Counting Backward

- Have the child tell you what every odd number ends with. [1, 3, 5, 7, or 9]
- Have the child skip count by odd numbers from 1 to 25.
- Have the child count backward from 20 to 1.

- **Read to the child:** We often use memorization in math. For example, it can be helpful to memorize doubles addition. Let's practice doubles addition problems from Math 1. Point to each problem and say the answer aloud. **Repeat as many times as desired.**

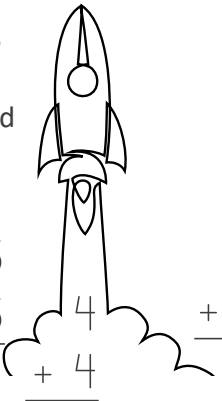
9	8	7	6	5		3
+ 9	+ 8	+ 7	+ 6	+ 5		+ 3
—	—	—	—	—	4	—
				4		
				—		—

Often we use logic in math. Logic means “a reasonable way of thinking about something.” Thinking logically helps you to come up with the most reasonable solution. Throughout this course, we will practice logic through activities that use our stars.

- **Take the stars from the math box. Work through the puzzles with the child, helping him or her to use logic to place the stars in the correct boxes.**

# Star LOGIC

## PUZZLE 1

Use 1 red star, 1 yellow star, and 1 purple star.



Clue 1: The yellow star is next to both the red star and the purple star.

Clue 2: The red star is not first, and it is not next to the purple star.

--	--	--



## PUZZLE 2

Use 1 brown star, 1 orange star, and 1 light-green star.



Clue 1: The brown star is to the right of the orange star.

Clue 2: The orange star is to the right of the light-green star.

--	--	--

## PUZZLE 3

Use 1 red star, 1 yellow star, and 1 pink star.



Clue 1: The red star is on the left side of the pink star.

Clue 2: The yellow star is not in the first box.

--	--	--



## How Many \$5 Bills?

- Take the \$5 bills out of the math box. Have the child figure out and hand you the number of \$5 bills needed to buy each item.



## How Many \$20 Bills?

- Take the \$20 bills out of the math box. Have the child figure out and hand you the number of \$20 bills needed to buy each item.



## INDEPENDENT REVIEW

Write and complete the problem for the story.

Eric saw 50 butterflies at 8:00 AM. He saw 50 more butterflies at 9:00 AM. How many butterflies did he see in total?



$$\square - \square = \square$$

Write and complete the problem for the story.

Kevin had 17 grapes on his vine. He picked 12 grapes. How many grapes does he have left on the vine?

$$\begin{array}{r} \square \\ \square \\ \hline \square \end{array}$$



Lesson  
**16**

**DOUBLES ADDITION  
PLUS 1**

Time

- Take the clock from the math box and have the child set the clock to the following times:

half past 2 | 3:25 | 4:55 | 6:30 | 6:45 | half past 9

- Have the child point to the quarters of the clock and say the minutes 15, 30, 45, 00.

- Read to the child:** You have been memorizing doubles addition—when two of the same number are added together, like  $4 + 4$  and  $8 + 8$ . Memorizing these math facts makes solving a problem like  $9 + 9$  a lot faster than counting up by ones from 9.

Today, you are going to learn doubles addition plus one. Look at the doubles addition problem in purple. What is the answer to the problem? [8] Now look at the problem in blue. It is not doubles addition; it is doubles addition plus one. The number 5 is one more than 4, so instead of adding  $5 + 4$ , you can add  $4 + 4$  and then add one more.

$$\begin{array}{r} 4 \\ + 4 \\ \hline \end{array} \quad \begin{array}{r} 5 \\ + 4 \\ \hline \end{array} \quad \text{the same as} \quad \begin{array}{r} 5 \\ + 4 \\ \hline \end{array} \quad (4 + 1)$$

Fill in the gray boxes for the problems:

$\begin{array}{r} 8 \\ + 8 \\ \hline \end{array}$	$\begin{array}{r} 9 \\ + 8 \\ \hline \end{array}$	$\begin{array}{r} 7 \\ + 7 \\ \hline \end{array}$	$\begin{array}{r} 8 \\ + 7 \\ \hline \end{array}$
---	---	---	---

$\begin{array}{r} 5 \\ + 5 \\ \hline \end{array}$	$\begin{array}{r} 6 \\ + 5 \\ \hline \end{array}$
---	---

$\begin{array}{r} 6 \\ + 6 \\ \hline \end{array}$	$\begin{array}{r} 7 \\ + 6 \\ \hline \end{array}$
---	---

$\begin{array}{r} 3 \\ + 3 \\ \hline \end{array}$	$\begin{array}{r} 4 \\ + 3 \\ \hline \end{array}$
---	---

$\begin{array}{r} 9 \\ + 9 \\ \hline \end{array}$	$\begin{array}{r} 10 \\ + 9 \\ \hline \end{array}$
---	--

- Read to the child:** Draw a line from each problem in the right column to the doubles addition problem in the left column you would use to help complete it.

$$\begin{array}{r} 8 \\ + 8 \\ \hline \end{array}$$

$$\begin{array}{r} 8 \\ + 7 \\ \hline \end{array}$$

$$\begin{array}{r} 7 \\ + 7 \\ \hline \end{array}$$

$$\begin{array}{r} 9 \\ + 8 \\ \hline \end{array}$$

$$\begin{array}{r} 5 \\ + 5 \\ \hline \end{array}$$

$$\begin{array}{r} 7 \\ + 6 \\ \hline \end{array}$$

$$\begin{array}{r} 6 \\ + 6 \\ \hline \end{array}$$

$$\begin{array}{r} 6 \\ + 5 \\ \hline \end{array}$$

- Have the child circle the addition problems that are doubles addition plus one.

$$\begin{array}{r} 6 \\ + 5 \\ \hline \end{array}$$

$$\begin{array}{r} 7 \\ + 5 \\ \hline \end{array}$$

$$\begin{array}{r} 5 \\ + 4 \\ \hline \end{array}$$

$$\begin{array}{r} 8 \\ + 6 \\ \hline \end{array}$$

# That's My Apple Tree

- **Read to the child:** The addition problem below each apple tree shows how many apples are on each tree. It would be a lot faster to calculate how many apples are on the tree by doing a doubles addition plus one problem than to count all the individual apples. Let's play a game called "That's My Apple Tree."
1. On a piece of paper, you write down one of these numbers in purple and don't let me see it: 3, 7, 9, 11, 13, 15, 17, 19.
  2. I will point to a doubles addition plus one problem, and you complete it aloud. If the answer does not match the number you wrote down, I will point to another problem. If the answer matches the number you wrote down, say, "That's my apple tree!" The game is over when I find your apple tree. **Repeat the game as many times as desired.**

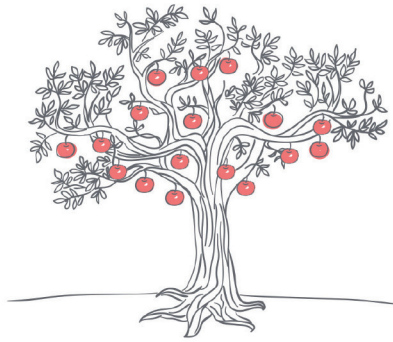

$$8 + 9$$

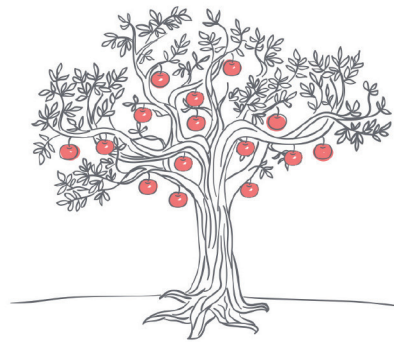

$$7 + 8$$

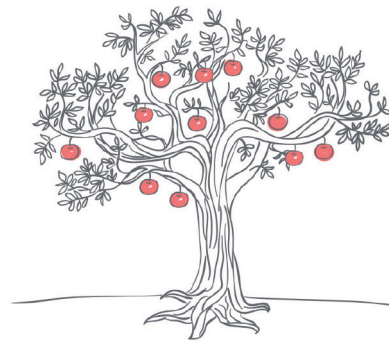

$$5 + 6$$

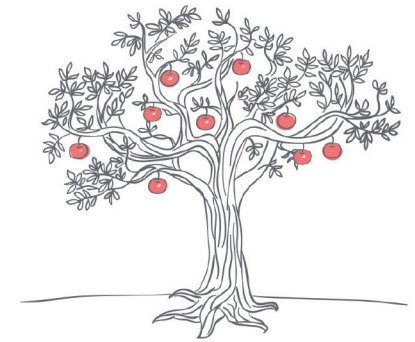

$$4 + 5$$



$$9 + 10$$



$$3 + 4$$

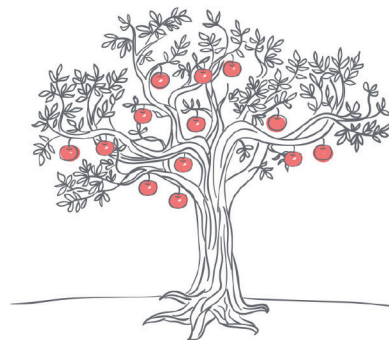

$$6 + 7$$



$$1 + 2$$



## TIME: PART 4

## Time

Ask when a new day starts [12 AM] and what time noon is. [12 PM] Have the child repeat the poem several times.

AM is the morning when birds wake up and sing.  
PM is the evening when songbirds go to sleep.





- **Get a timer or pull up a timer on your phone. Read to the child:** There are 60 seconds in a minute. Let's watch a minute go by on the timer and count with it. **Count with a timer for a minute.** That was one minute. An hour has 60 minutes in it. So, if we sat here and watched a minute go by 60 times, that is how long an hour would take. One day has 24 hours. Look at the picture of the castle garden on the next page. I will tell you about an activity. You will point to the place on the picture where the activity would take place and tell me if it would be more likely to take 2 seconds, 2 minutes, or 2 hours.

- Cut four roses from a rose bush.
- Throw one handful of seeds to the birds.
- Trim all the rose bushes.
- Run through the maze.
- Sit on the bench and read a long book.
- Have a picnic on the grass and play a long board game.
- Put all the food back into the picnic basket and fold the blanket.
- Throw a penny into the fountain.
- Sing one song to the birds.
- Paint a detailed picture of the castle gardens.

- **Read to the child:** Write the correct number on the crown to complete the problem. Then say the phrase aloud. [1 hour equals 60 minutes, etc.]

1 hour =  minutes

1 day =  hours

1 minute =  seconds

- **Read to the child:** How many hours are in one day? [24] Let's suppose you stay at the castle for 2 days. Write and complete a problem to find out how many hours you will spend in the castle in total.

- **Read to the child:** It takes 2 hours to drive to the castle. Write and complete a problem to find out how many minutes it takes you to drive to the castle.

# Time at the Castle

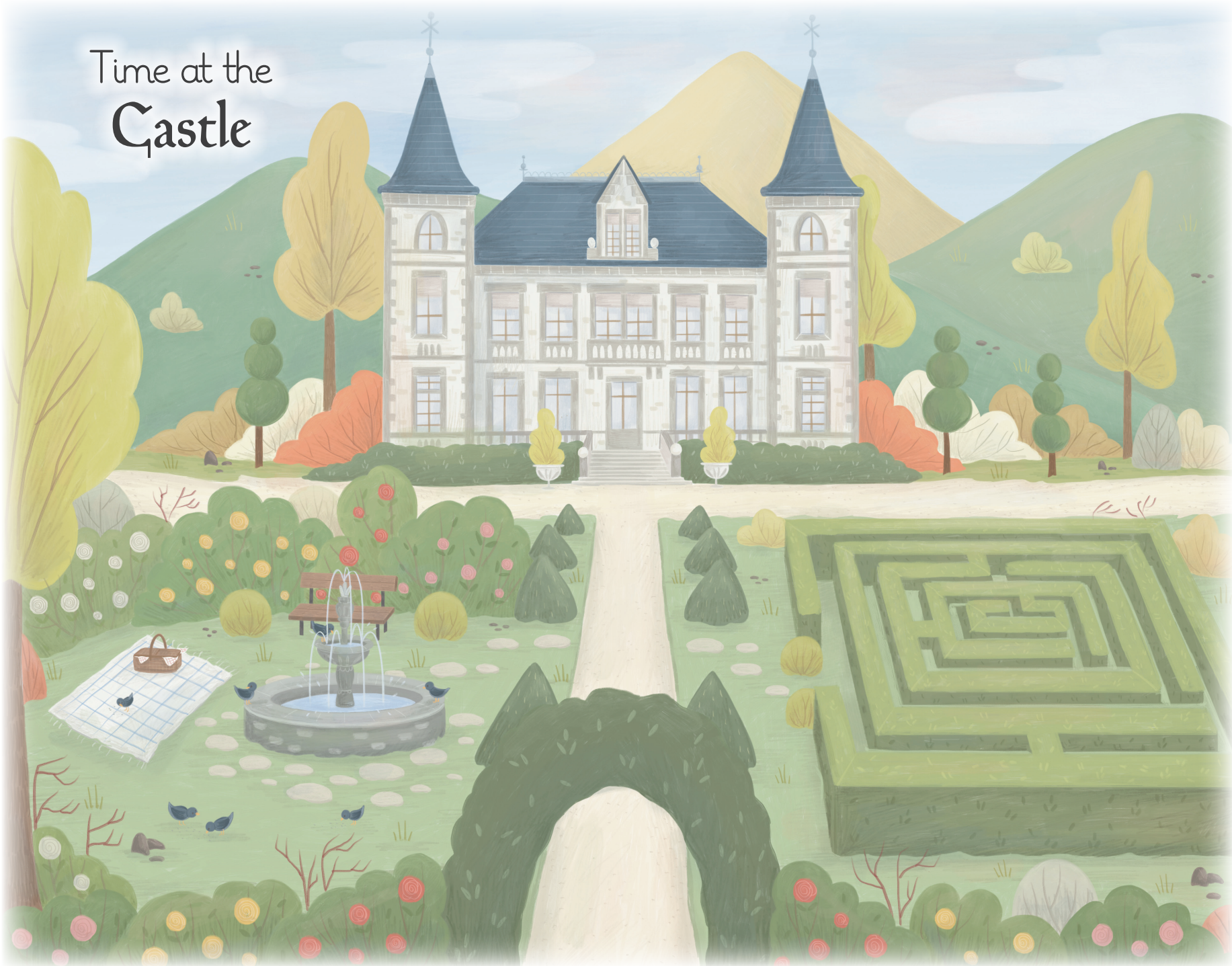

# UNIT ASSESSMENT



## Parent/Teacher

Read the following information aloud to the child: Unit assessments give you practice with the math concepts learned in this unit without over practicing concepts that you have mastered. These assessments also give you practice working on math problems for an extended period of time. This helps you extend focus and attention span and to be better prepared for any type of testing you will have to do in the future. Here are some tips. First, make sure to always read the instructions carefully. Sometimes you can get answers wrong simply because you did not understand the instructions. Second, do not rush through exercises you think you already know. Instead, make sure to do your work carefully. Sometimes you can get answers wrong, even though you understand the concept, just because you rushed.

For Lesson 32 have the child complete all the exercises with purple headers only. At this level you may need to read all or some of the instructions to the child. Correct the work. If the child makes one or more mistakes in a section, explain the concept and check the orange “Additional Practice” checkbox for that section.

For Lesson 33 have the child complete all the orange sections **that are checked**. If the child still makes multiple mistakes, make sure the child understands why. All the principles will be reviewed again in upcoming units. If the child has only a few or no orange sections to practice, the child may spend time doing math games or move on to the next lesson.

Note: All concepts in Unit 1 will be reviewed throughout the rest of the course, but less frequently.



## Student

### SKIP COUNTING

Figure out what number each row is skip counting by and fill in the missing numbers.

3		9				
	20	30				70
25	50	75				
50		150				



### Additional Practice

Skip count by the first number shown, filling in the blank lines.

3, \_\_\_\_\_, \_\_\_\_\_, \_\_\_\_\_, \_\_\_\_\_, \_\_\_\_\_, \_\_\_\_\_

10, \_\_\_\_\_, \_\_\_\_\_, \_\_\_\_\_, \_\_\_\_\_

25, \_\_\_\_\_, \_\_\_\_\_, \_\_\_\_\_, \_\_\_\_\_

50, \_\_\_\_\_, \_\_\_\_\_, \_\_\_\_\_, \_\_\_\_\_





## COINS: PART 1



Write the amount of money shown in each group. Use the cent sign. Remember to count the coins with the highest value first.



### Additional Practice

Write the correct numbers in the yellow boxes.



1 dime is how many nickels?



1 quarter is how many nickels?



1 nickel is how many pennies?



1 half-dollar is how many dimes?



## PLACE VALUE



Circle the number of base-10 items needed to represent each number.

104

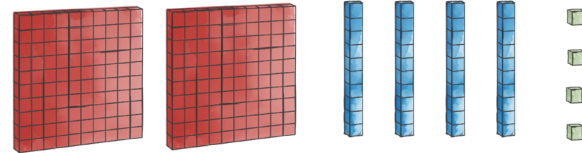

230

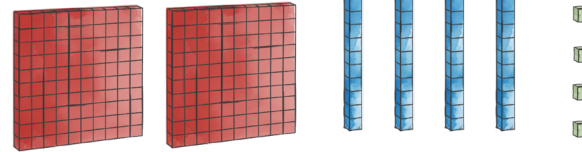

### Additional Practice

Circle the number of base-10 items needed to represent each number.

113

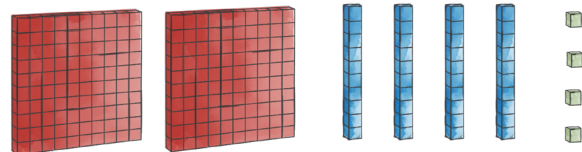

201

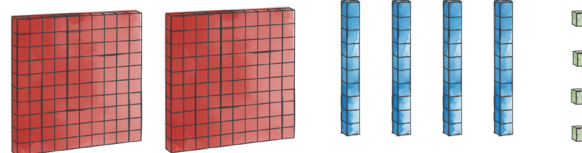

## GREATER THAN, LESS THAN, EQUAL

In each circle write the greater than, less than, or equal sign.

678 ○ 67      500 ○ 678

|||||      ○      |||||

\$20      ○      \$50      \$10

### Additional Practice

In each circle write the greater than, less than, or equal sign.

567 ○ 556      300 ○ 300

|||||      ○      |||||

\$20      ○      \$50      \$5

## COINS: PART 2

Draw a line between the coins in each group to divide the total value in half.



### Additional Practice

Draw a line between the coins in each group to divide the total value in half.



# UNIT 2 OVERVIEW

## LESSONS 34-61

### Extra Supplies Needed

- 12-inch ruler
- 30-centimeter ruler
- bowl
- scissors

### New Concepts Taught

- Add 3 one-digit numbers
- Add and subtract 10
- Add and subtract 100
- Add and subtract money
- Add numbers with three or more digits
- Check addition with subtraction
- Commutative property
- Elapsed days and weeks
- Elapsed time to hours, half hours
- End time
- Fact families
- Identify feet and yards
- Identify fractions
- Measure length in the metric system
- Measure length in the US customary system
- Measure using inches and centimeters
- Mental addition
- Regroup in addition
- Spell number words up to 19
- Tell time to the quarter hour and minute
- Thermometers
- Write numbers in expanded form

### Parent/Teacher Tips

- To make math and learning apply even more to real life, think of times throughout the day that you can point out principles you are learning. Here are some examples:
  - “Look! It’s 2:30 PM. What time will it be in half an hour?”
  - “Those croissants look delicious! How many would we buy if we wanted a dozen of them?”
  - “Hey, there are 6 bananas in that bunch. If we’re rounding to the nearest 10, would that round down to 0 or up to 10?”
  - “Look at that caterpillar! Would you measure it in inches or feet?”
  - “Now if I divide this cake into 6 pieces and give you 1 piece, what fraction of the cake did I give you?”
- Even if the child can do the activities in the opening box, reviewing helps increase speed and cement principles long-term. However, look for cues that the child is getting tired of a certain activity if it is already mastered.
- A real thermometer can be a lot of fun for the thermometer lesson in Lesson 58. You can measure body temperature and the temperature of cups of cold and warm water.



Lesson  
**34**

**ADD AND SUBTRACT 10  
AND 100**

Spelling 13. 14. 15 & Tally Marks

- Have the child write “thirteen,” “fourteen,” and “fifteen” on the whiteboard.
- Have the child write 18 tally marks on the whiteboard.



- **Read to the child:** To add 10 to a number, we *increase* the digit in the tens place by one. The number 784 is on the first chart. Point to the digit in the tens place. [8] In the next chart, write the sum of  $784 + 10$  by increasing the digit in the tens place by one. [794]

Hundreds	Tens	Ones	Hundreds	Tens	Ones
7	8	4	7		4

- **Read to the child:** Add 10 to each number by increasing the digit in the tens place by one.

Hundreds	Tens	Ones	Hundreds	Tens	Ones
6	4	3			
3	0	5			
	2	9			

- **Read to the child:** To subtract 10 from a number, we *decrease* the digit in the tens place by one. Subtract 10 from each number by decreasing the digit in the tens place by one.

Hundreds	Tens	Ones	Hundreds	Tens	Ones
5	7	1			

Hundreds	Tens	Ones	Hundreds	Tens	Ones
8	9	0			

- **Read to the child:** To add 100 to a number, we *increase* the digit in the hundreds place by one. Add 100 to each number by increasing the digit in the hundreds place by one.

Hundreds	Tens	Ones	Hundreds	Tens	Ones
4	2	9			

Hundreds	Tens	Ones	Hundreds	Tens	Ones
2	8	6			

- **Read to the child:** To subtract 100 from a number, we *decrease* the digit in the hundreds place by one. Subtract 100 from each number by decreasing the digit in the hundreds place by one.

Hundreds	Tens	Ones	Hundreds	Tens	Ones
5	7	1			

Hundreds	Tens	Ones	Hundreds	Tens	Ones
8	9	0			

○ Take the squares 1–8 (with the stars on one side and numbers on the other side) from the math box and put them in a bowl. Read to the child: We are going to play a game. We will each randomly take three numbers out of the bowl and arrange them to make the greatest number possible. We will each write the number we create in the first box in our column below. Then we will follow the instructions to write

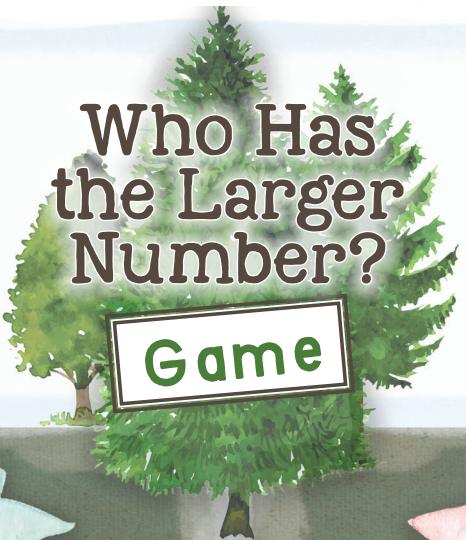

in the yellow box the number that is 100 more or less or 10 more or less than the number we created. The person with the larger number in the yellow box wins that round and gets to fill in the circle. We'll then put all the numbers back in the bowl and repeat the steps. The person with the most circles filled in at the end of the game wins. This is a game of chance, and it is not important who wins; it's just important to have fun!

## Child

## Parent/Teacher

Create Your Number	<input type="text"/>	10 more	<input type="text"/>	<input type="radio"/>
Create Your Number	<input type="text"/>	10 less	<input type="text"/>	<input type="radio"/>
Create Your Number	<input type="text"/>	100 more	<input type="text"/>	<input type="radio"/>
Create Your Number	<input type="text"/>	100 more	<input type="text"/>	<input type="radio"/>
Create Your Number	<input type="text"/>	100 less	<input type="text"/>	<input type="radio"/>

Create Your Number	<input type="text"/>	10 more	<input type="text"/>	<input type="radio"/>
Create Your Number	<input type="text"/>	10 less	<input type="text"/>	<input type="radio"/>
Create Your Number	<input type="text"/>	100 more	<input type="text"/>	<input type="radio"/>
Create Your Number	<input type="text"/>	100 more	<input type="text"/>	<input type="radio"/>
Create Your Number	<input type="text"/>	100 less	<input type="text"/>	<input type="radio"/>



# INDEPENDENT REVIEW

Write the missing letters for each number.

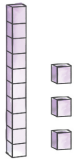

\_\_\_\_\_teen

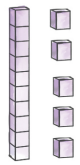

\_\_\_\_\_teen

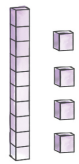

\_\_\_\_\_teen

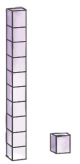

el\_\_\_\_\_

Complete the statements below by writing the number of coins on the right needed to equal the coins on the left.



1 dime =  nickels



1 quarter =  nickels



1 nickel =  pennies



2 quarters =  nickels

Find the sums, and then write the correct symbol in each circle: greater than, less than, or equal.

$$\begin{array}{r} 13 \\ + 3 \\ \hline \end{array}$$



$$\begin{array}{r} 9 \\ + 2 \\ \hline \end{array}$$

$$\begin{array}{r} 19 \\ + 10 \\ \hline \end{array}$$



$$\begin{array}{r} 15 \\ + 4 \\ \hline \end{array}$$

$$\begin{array}{r} 10 \\ + 8 \\ \hline \end{array}$$



$$\begin{array}{r} 12 \\ + 6 \\ \hline \end{array}$$

$$\begin{array}{r} 16 \\ + 3 \\ \hline \end{array}$$



$$\begin{array}{r} 18 \\ + 11 \\ \hline \end{array}$$

Use this calendar to fill in the boxes below.

April 2025						
Sunday	Monday	Tuesday	Wednesday	Thursday	Friday	Saturday
		1	2	3	4	5
6	7	8	9	10	11	12
13	14	15	16	17	18	19
20	21	22	23	24	25	26
27	28	29	30			

- Write the date circled in green.
- Write the date one week from the date circled in green.
- Circle the day of the week that May 1st will be.
 

Sunday   Monday   Tuesday   Wednesday  
 Thursday   Friday   Saturday

Lesson  
**38**

**ADDING NUMBERS WITH THREE OR MORE DIGITS**

Measurement

**Ask the child:** How many inches are in a foot? [12] How many feet are in a yard? [3]

- **Read to the child:** The number 15 has two digits, a one and a five. The number 125 has three digits, a one, a two, and a five. When adding numbers with three or more digits, we will start with the ones and then move left. Write the sum below each column.

$\begin{array}{r} 423 \\ + 353 \\ \hline \end{array}$	$\begin{array}{r} 345 \\ + 242 \\ \hline \end{array}$	$\begin{array}{r} 744 \\ + 253 \\ \hline \end{array}$

- **Read to the child:** Now try these problems by regrouping or carrying.

$\begin{array}{r} \square \\ 336 \\ + 356 \\ \hline \end{array}$	$\begin{array}{r} \square \\ 428 \\ + 538 \\ \hline \end{array}$	$\begin{array}{r} \square \\ 247 \\ + 247 \\ \hline \end{array}$

- **Read to the child:** Complete the problems below, which add three-digit numbers with two-digit or one-digit numbers. If there is a blank spot, imagine it is a zero.

$\begin{array}{r} \square \\ 423 \\ + 53 \\ \hline \end{array}$	$\begin{array}{r} \square \\ 537 \\ + 57 \\ \hline \end{array}$	$\begin{array}{r} \square \\ 548 \\ + 8 \\ \hline \end{array}$

- **Read to the child:** Now you have learned enough to add huge numbers. Here is a fact about a huge number. Mars is over 56 million miles away from us! Try adding these numbers, which are in the millions! Start with the ones column, and then go left and continue moving to the next place value to the left until you have added all the digits.

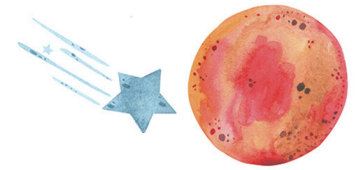

$2,352,034$	$+ 3,430,342$



# ... INDEPENDENT REVIEW ...

## ✈️ Airport Parking

Circle all the numbers on the runway that are odd numbers.

Round the number on each boat up to 10 or down to 0 and write it on the blank sail.



333

782

321

428

359

326

247

789

100

235

Circle the hangar numbers that are greater than 12.

Write the number word for each plane number.

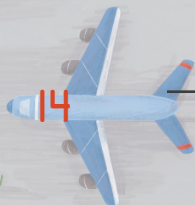

### Check Your Addition Problems with Subtraction

$$\begin{array}{r}
 3 \\
 + 2 \\
 \hline
 \square
 \end{array}
 \quad
 \begin{array}{r}
 \square \\
 - 2 \\
 \hline
 \square
 \end{array}$$

$$\begin{array}{r}
 4 \\
 + 3 \\
 \hline
 \square
 \end{array}
 \quad
 \begin{array}{r}
 \square \\
 - 3 \\
 \hline
 \square
 \end{array}$$

Lesson  
**40**

**ADDING DOLLARS AND CENTS**

**Clock Work**

Take the clock from the math box and have the child set the clock to the following times:

half past 7 | 3:25 | 4:15 | 9:30 | 6:45 | 3:00 |  
half past 1

- **Read to the child:** Let's learn about adding dollars and cents. Look at the problem in the next column. Point to the green column. This column shows the number of pennies. We call it the hundredths place. It takes 100 pennies to make a dollar. Point to the blue column. This column shows the number of dimes. We call it the tenths place. It takes 10

dimes to make a dollar. Point to the decimal point, which looks like a period. Decimal points mark the space between whole and partial amounts. When adding money, decimal points separate the whole dollars from the partial dollars (cents). Point to the purple column. This is the ones place (dollars).

	dollars	dimes	pennies
\$	8	2	0
+	6	3	5
<hr/>			

Look at the first problem on the chalkboard. We need to add \$3.31 and \$2.20. Start with the hundredths place, then the tenths place, then the ones place. Write the decimal point in your answer right below the decimal points in the problem. Also, add a dollar sign to the answer.

Complete all the problems on the chalkboard. Remember to include the decimal point and dollar sign in each answer.

$\$3.31$	$\$5.37$	$\$3.16$	$\$6.05$
$+\$2.20$	$+\$2.42$	$+\$6.13$	$+\$3.85$
<hr/>	<hr/>	<hr/>	<hr/>



# Building Birdhouses

○ Read to the child: Andrew wants to build a birdhouse, but he only has \$6.30 for materials. He needs to know which birdhouse he can build. For each birdhouse he needs wood, nails, paint, and a paintbrush. Birdhouses One and Two need different amounts of material.



One

$$\begin{array}{r}
 \$1.20 \quad \text{wood} \\
 + \$0.75 \quad \text{nails} \\
 \hline
 \end{array}$$





Two



$$\begin{array}{r}
 \$1.98 \quad \text{wood} \\
 + \$0.95 \quad \text{nails} \\
 \hline
 \end{array}$$

Andrew has only enough money to build one of the birdhouses. Which one do you think it is? Let's find out if you are right. For each birdhouse first add the cost of the wood and nails. Then add the cost of the paint and paintbrush. Then add the sums (answers) of those two problems to find the total. If Andrew has \$6.30 to spend, which birdhouse can he build?

$$\begin{array}{r}
 \$2.20 \quad \text{wood} \\
 + \$1.05 \quad \text{paint} \\
 \hline
 \end{array}$$

$$\begin{array}{r}
 \$3.20 \quad \text{wood} \\
 + \$1.05 \quad \text{paint} \\
 \hline
 \end{array}$$



# MEASURING: PART 1

## Mental Math

**Read to the child:** An easy way to add 100 to any number is to increase the digit in the hundreds place by one. Mentally complete the problems in purple. Say the answers aloud.

220 + 100   415 + 100   637 + 100   706 + 100

## Expanded Form

On a whiteboard have the child write the expanded form for these numbers: 112 [100 + 10 + 2], 205 [200 + 0 + 5], and 760 [700 + 60 + 0].



- Give the child a 12-inch ruler. **Read to the child:** Point to the inch lines on the ruler. How many are there? Halfway between each inch is a half-inch line. Point to each half-inch line. How many halves are in a whole? [2] Half of 1 is one-half. Half an inch is written like this. **Write "1/2" on the whiteboard.** With your ruler, measure the line segments below and write the lengths in the blank boxes. Remember to start measuring the line segment at zero on the ruler.

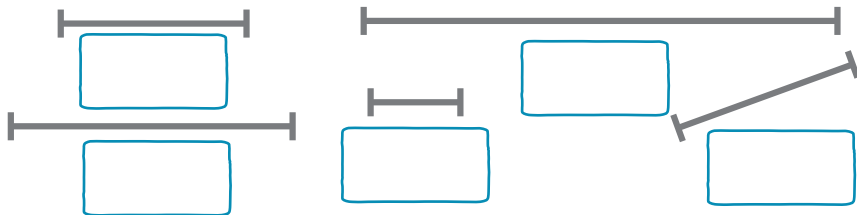

- On a piece of scratch paper, have the child use the ruler to create a  $2\frac{1}{2}$ -inch and a  $3\frac{1}{2}$ -inch line segment.

- Read to the child:** Tina owns a frame shop where she frames tiny paintings. Today, she is working on framing some paintings by Vincent van Gogh, one of the most famous painters in history. He created about 2,100 works of art in his lifetime. Tina needs to



← length →

1



↑ height ↓

measure the length and the height of each painting before she prepares the frames. Using your ruler, measure the length and height of each painting and write the number of inches in the box. Use the abbreviation "in" or use the inch sign: ".



← length →

2



↑ height ↓





## INDEPENDENT REVIEW



In each box write the total time it took Tina to make the frame for each painting. The start and end times are given. When you have half-hour increments, write them like this:  $1\frac{1}{2}$  hours,  $2\frac{1}{2}$  hours, and so on.



Started: 10:00 AM  
Ended: 11:30 AM

hours



Started: 1:00 PM  
Ended: 2:30 PM

hours



Started: 1:00 PM  
Ended: 3:00 PM

hours



Started: 3:00 PM  
Ended: 3:30 PM

hours

Paintings by Vincent van Gogh (1853–1890)

1. "Fishing Boats on the Beach," 1888
2. "The Harvest," 1888
3. "Field with Poppies," 1888
4. "Landscape at Twilight," 1890
5. "Olive Trees with the Alpilles in the Background," 1889
6. "Road with Cypress and Star," c. 1890



- **Read to the child:** We measure the distance an airplane flies in miles or kilometers. This airplane can fly 175 miles in an hour. That means it takes this airplane about 20 seconds to fly a mile! That is much faster than walking a mile in 20 minutes! Look at this image. About how many kilometers can the airplane travel in the same distance as four miles?

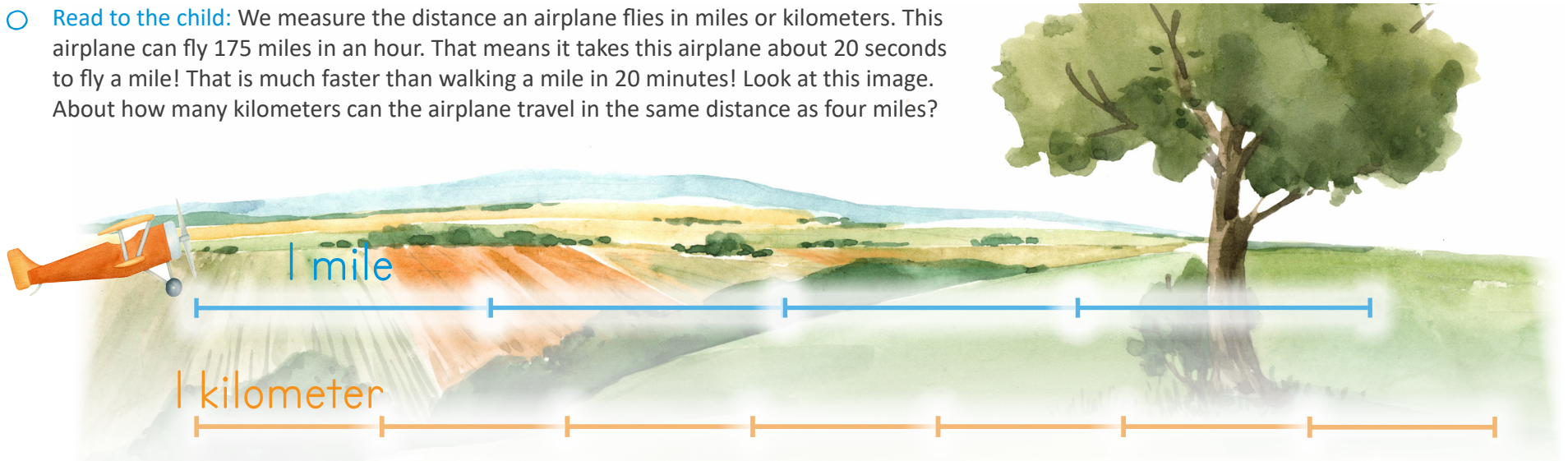

- **Take an airplane from the math box. Read to the child:** Let's do an activity to review what we learned in this lesson. I will read you a sentence, and you place the airplane on the airport that is labeled with the right answer. **Read to the child the following questions and statements. Check the answer key for answers if needed. Repeat the set of questions as many times as needed.** 1) You can walk this far in about 20 minutes. 2) You can walk this far in about 12 minutes. 3) Would you use yards or miles to measure the length of a kitchen table? 4) Which is longer: a mile or a kilometer? 5) Would you use meters or kilometers to measure your height? 6) Which is longer: a yard or a meter? (Look at the wagon picture on the previous page.) 7) What would you measure the size of an ocean with: miles or yards? 8) What would you measure the height of a tree with: kilometers or meters? 9) What would you measure the length of a boat with: miles or yards?

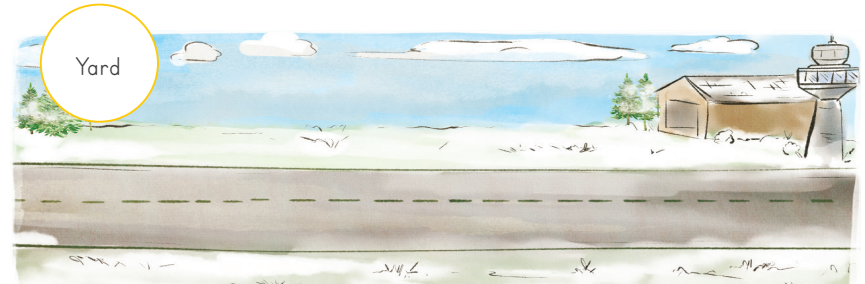
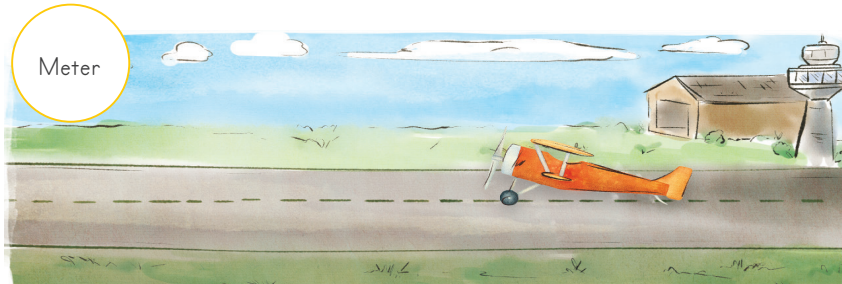
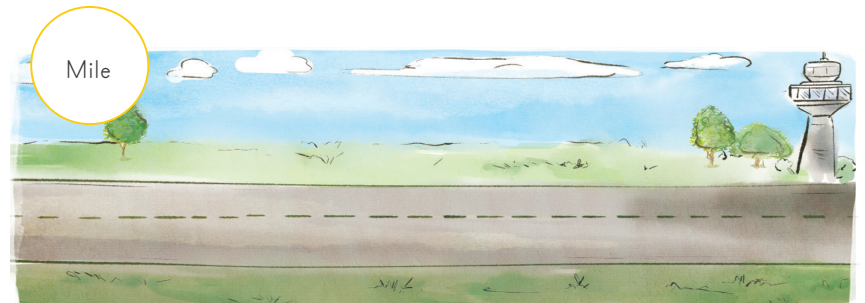
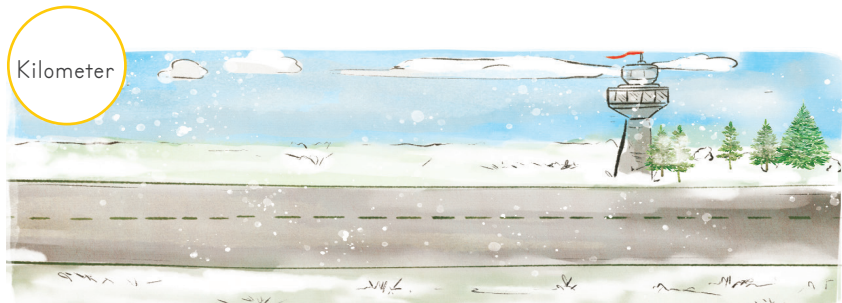



# UNIT 3 OVERVIEW

## LESSONS 62-90

### Extra Supplies Needed

- scissors
- small bowl

### New Concepts Taught

- Add 3 two-digit numbers
- Add and subtract 10 and 100 to numbers in the thousands
- Compare fractions
- Compare weights
- Count and write in the thousands
- Divide into groups
- Divide with one left over
- Missing numbers in addition problems
- Multiplication
- Multiplication story problems
- Place value to the thousands
- Polygons
- Regroup in subtraction
- Rounding in addition and subtraction
- Two-step story problems
- Venn diagrams
- Weight in grams and kilograms
- Weight in ounces, pounds, and tons

### Parent/Teacher Tips

- If the child wants more math after finishing a lesson, that is a cue that the child can be progressing faster. Consider doing another half or full lesson each day until it feels like too much.
- If the child is overwhelmed with lessons, try to determine the cause so you can work on fixing it. Here are some questions to ask yourself:
  - Can the child do basic addition and subtraction quickly? (If not, consider pausing the course and working on those skills for a while.)
  - Is the child not understanding a lot of the principles? (If so, consider moving back a level or slowing down.) Or is the problem the lesson length? (If so, consider moving to half a lesson a day for a while.)
  - Some children in Math 2 have not learned to form numbers correctly and are frustrated when they have to do a lot of writing. Does the child seem less overwhelmed if he or she says the answers aloud and you write them? (If so, consider pausing the course to work on writing numbers. Consider a fun challenge like making a reward chart for writing each number correctly 100 times.)

Lesson  
**64**

**PLACE VALUE TO THE THOUSANDS**

Skip Counting

Have the child skip count backward by 3s from 21 to 3.

Fractions

Play the "Fraction Dice Game." (Instructions are on page 145.)

**Fraction Dice Game**

**Child**      **Teacher**

□ □ □      □ □ □

- **Read to the child:** Madison played at three other churches and concert halls on her tour. Fill out the orange chart by each location to find out how many people were in the audience at each location. Then read the number aloud. Don't forget the comma after the digit in the thousands place.

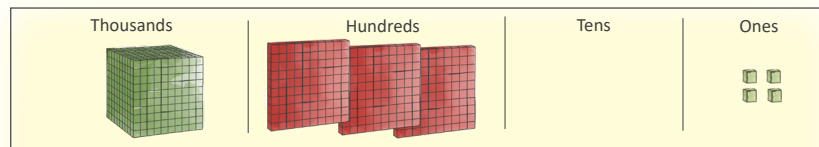

Thousands	Hundreds	Tens	Ones

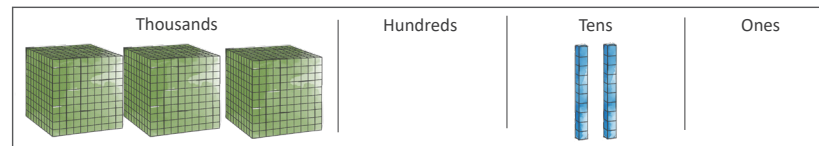

Thousands	Hundreds	Tens	Ones

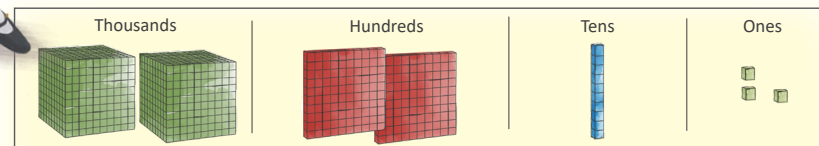

Thousands	Hundreds	Tens	Ones



- **Read to the child:** Madison has been playing the flute since she was eight years old. She plays in an orchestra, and they went on tour. At the first performance on their tour, there were 2,232 people in the audience. The chart below shows 2,232 with base-10 blocks. The green cubes are thousand cubes. They each have 10 hundred squares, which is 1,000 total blocks. In the orange chart, write the number of thousand cubes in the thousands place and write a comma after the digit. Then write the number of hundred squares, ten sticks, and one blocks shown.
- **Read to the child:** Read each number in green aloud. What digit is in the thousands place? Hundreds place? Ones place? Tens place?

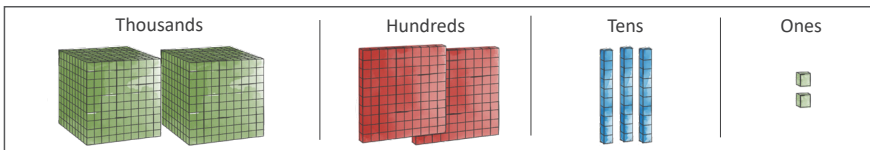

Thousands	Hundreds	Tens	Ones

9,802    8,003    7,300    4,020

# INDEPENDENT REVIEW

Complete the fact family using the numbers at the top.

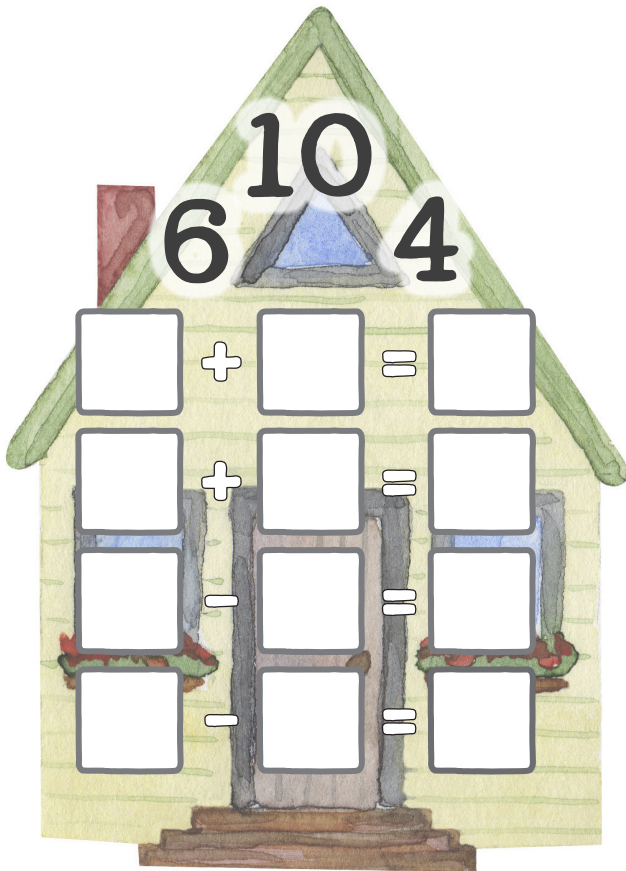

Write the number of days in each month. If needed, reference the poem on page 152.

July



August



September



Complete the subtraction problems. Don't forget to borrow and regroup.

$$\begin{array}{r} 85 \\ - 47 \\ \hline \end{array}$$

$$\begin{array}{r} 66 \\ - 37 \\ \hline \end{array}$$

$$\begin{array}{r} 92 \\ - 37 \\ \hline \end{array}$$

Fill in the missing number, counting by thousands.

3,000

5,000

Round each number to the nearest ten.

38

31

35



39

34

32

37



# Madison's

## Practice Book

Write the ending times on Madison's practice book. Make sure to include AM or PM.

Day of the Week	Length of Practice	Time Started	Time Ended
Monday	30 minutes	9:00 AM	
Tuesday	1 hour 30 minutes	8:00 AM	
Wednesday	1 hour 30 minutes	2:00 PM	
Thursday	30 minutes	5:30 PM	
Friday	1 hour 30 minutes	5:00 PM	
Saturday	30 minutes	10:00 AM	





Lesson  
**68**

**ESTIMATING WITH  
SUBTRACTION**

Spelling Numbers

Have the child write "eleven," "sixteen," "seventeen," and "eighteen" on the whiteboard.

- **Read to the child:** In some caves, water drips from the ceiling over many years, forming stalagmites on the cave floor, as shown on the right. We are going to practice subtracting one number from another and rounding the answer to the nearest ten. Look at the example in the blue box on the right. Complete the subtraction problems below on a whiteboard (write them vertically—up and down), and then round the answer to the nearest ten and write it in the stalagmite. Remember, when rounding to the nearest ten, a number ending in five or greater rounds up.



$27 - 13 = 14$   
14 rounded to the nearest ten is 10

$24 - 11$



$18 - 2$



$36 - 15$



- **Read to the child:** Make your way out of the cave on this page by completing each subtraction problem on a whiteboard. Then write each answer rounded to the nearest ten in the box.

**CAVE ROUNDING**

**END**

$24 - 9$

$32 - 16$

$12 - 8$

$22 - 10$

$26 - 4$

$36 - 13$

$16 - 7$

$24 - 3$

**START**



# INDEPENDENT REVIEW

Complete the problems and follow the answers until you get to the end.

**Start**

$3 + 2 + 5$	10	$25 + 25 + 4$	54	$25 + 25 + 25$	75	$50 + 50 + 3$	150	$10 + 8 + 10$
13		45		10		103		18
$6 + 6 + 6$	6	$25 + 40 + 1$		$25 + 25 + 10$	15	$5 + 5 + 10$		
18		54		60		25		
$5 + 2 + 5$	15	$25 + 25 + 7$		$50 + 25 + 4$	4	$50 + 10 + 10$		
21		16		79		80		
$8 + 3 + 8$	14	$8 + 50 + 50$	108	$4 + 8$	12	$4 + 1 + 6$	11	<b>End</b>

**The Way of the Wolf**

Fill in the missing addend. If needed, draw the missing number of dots on the domino to help you find the answer.

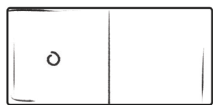

$1 + \square = 7$

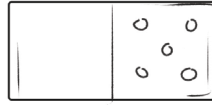

$\square + 5 = 11$

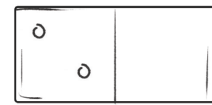

$2 + \square = 5$



## FRACTIONS: PART 3

## Mental Math

Have the child look at each problem below, identify if there's a doubles addition fact that can help complete the problem or not, and say the answer aloud.

14	13	10	18	8	12
<u>- 7</u>	<u>- 3</u>	<u>- 5</u>	<u>- 9</u>	<u>- 4</u>	<u>- 6</u>

- **Read to the child:** Miguel's family owns a watermelon farm. One day his mother slices a ring of watermelon and divides it into six equal parts. The ring of watermelon was one whole until it was cut. Each piece cut is a fraction of the whole ring. A fraction is part of a whole.

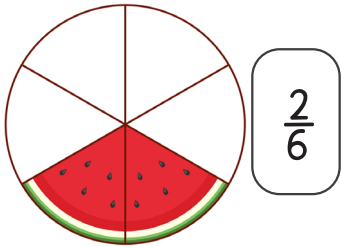

Look at this circle. How many pieces is it divided into? [6] Miguel and his sister took four of the pieces. How many pieces are left? [2] **Point to the fraction  $\frac{2}{6}$ .** Two-sixths of the watermelon ring is left. This is how we write the fraction two-sixths. Fractions have two numbers with a line between the numbers. The bottom number tells how many equal parts a whole is divided into. The top number tells how many parts we are referring to.

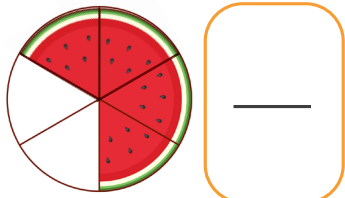
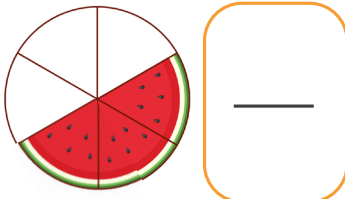

Write the missing fractions for these two rings of watermelon. Below the line write the total number of equal parts shown on the circle. Above the line write the number of parts left.

- **Read to the child:** Fill in the circles to show each fraction.

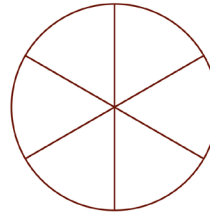

$\frac{1}{6}$

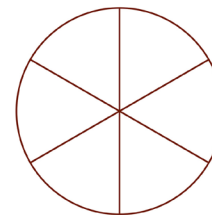

$\frac{3}{6}$

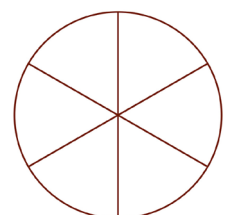

$\frac{5}{6}$

- **Read to the child:** Miguel's younger cousins came over, and Miguel's mother sliced a ring of watermelon into 10 pieces. Write the fraction of watermelon left for these rings of watermelon. Below the line write the total number of equal parts shown on the circle. Above the line write the number of parts left.

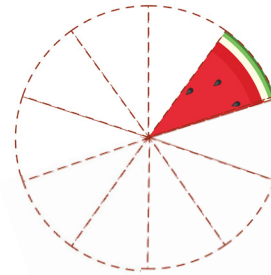

—

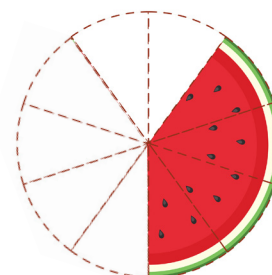

—

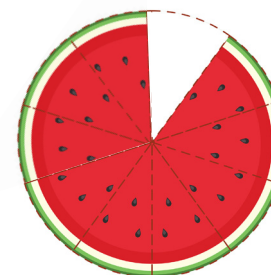

—

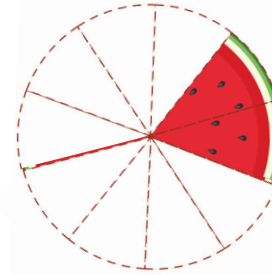

—

- **Take the numbers from the math box. Have the child create the following numbers, showing you where the comma goes:**

1,652 | 3,012 | 5,903

# INDEPENDENT REVIEW

Miguel and his father are driving to the watermelon patch. Help them find the path. Figure out the answer to each subtraction problem and follow the path that has the correct answer. Mark the path you take.

2

$8 - 6$	14	$17 - 3$	11	$15 - 4$	25	$50 - 25$		
3	6	4	1	3	3	15		
$7 - 1$	8	$12 - 6$	3	$17 - 5$	12	$20 - 12$	8	$30 - 15$
7	8	5	4	9	2	4	4	3
$8 - 3$	2	$6 - 5$	6	$15 - 6$	3	$8 - 5$	7	$6 - 3$
3	1	3	3	6	3	4	6	5
$5 - 2$	4	$13 - 4$	9	$11 - 5$	8	$5 - 1$	3	$7 - 4$
6	8	5	3	1	2	2	2	2
$12 - 4$	9	$18 - 9$	6	$12 - 6$	7	$14 - 7$	3	Start $6 - 3$

## Subtraction Maze

# INDEPENDENT REVIEW

Complete the problems. Then round the differences (answers) to the nearest 10 and write them in the purple boxes.

$$\begin{array}{r} 97 \\ - 73 \\ \hline \end{array}$$

Rounded Difference

$$\begin{array}{r} 86 \\ - 74 \\ \hline \end{array}$$

Rounded Difference

Complete the problems. Before adding each column, if there are two digits that together equal 10, connect them with a curved line as shown on the first problem. (You don't have to do this at other times; this is just for practicing one possible strategy.)

$$\begin{array}{r} 98 \\ 17 \\ + 62 \\ \hline \end{array}$$

$$\begin{array}{r} 55 \\ 15 \\ + 64 \\ \hline \end{array}$$

$$\begin{array}{r} 86 \\ 62 \\ + 26 \\ \hline \end{array}$$

$$\begin{array}{r} 27 \\ 33 \\ + 76 \\ \hline \end{array}$$

Write the number of days in each month. If needed, reference the poem on page 152.

July



August



September



March



Draw a line from each shape to its name. (Hints: "Octa-" means 8. "Hexa-" means 6. "Penta-" means 5.)



Triangle

Pentagon

Octagon

Hexagon

Trapezoid

Square

Fill in the missing boxes.

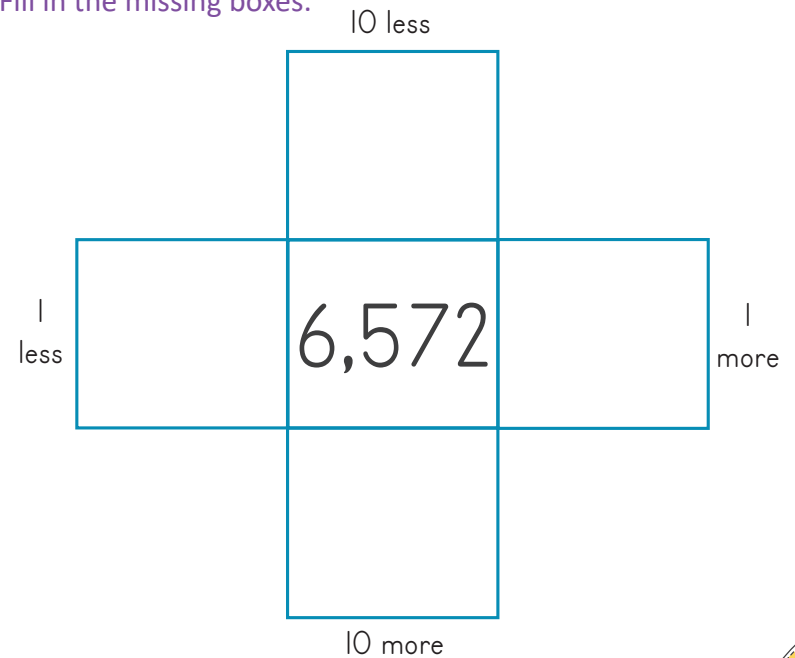



## MULTIPLICATION: PART 1

## Mental Math &amp; Skip Counting

- **Read to the child:** An easy way to add 9 to any number is to first add 10 and then subtract 1. Mentally complete the problems in purple. Say the answers aloud.

$$18 + 9 \quad 35 + 9 \quad 29 + 9 \quad 36 + 9 \quad 17 + 9$$

- Have the child count by 50s from 500 to 1,000.
- Have the child count by 5s from 900 to 1,000.

- **Read to the child:** Look at the painting on the next page. Today, we will use this painting to learn about multiplication. We use the  $\times$  sign when we multiply. **Multiplication** is a shortcut for adding equal groups together to find the total. Where would you plant a garden on this farm? The farmer has planted straight rows of cabbages. Let's suppose he planted 6 rows of plants, and there are 10 plants in each row. To figure out how many plants there are altogether, we could do this addition problem. Skip count to complete the problem:

$$10 + 10 + 10 + 10 + 10 + 10 =$$

How many times did you add 10 together? Yes, 6 times. We could use this multiplication problem instead of the addition problem:

$$6 \times 10 =$$

Multiplying 6 times 10 is the same as adding 10 six times.

Point to the stacks of hay in the field. Let's suppose there are 5 rows of hay and there are 3 stacks of hay in each row.

To figure out how many stacks of hay there are total, we could do this addition problem. Skip count to complete the problem:

$$3 + 3 + 3 + 3 + 3 =$$

How many times did you add 3 together? Yes, 5 times. We could use this multiplication problem instead of the addition problem:

$$5 \times 3 =$$

Multiplying  $5 \times 3$  gives us the same answer as adding 3 five times.

Now I am going to read you some math problems. For each math problem, write an addition problem that can answer the question, and then write a multiplication problem that can answer the question. Complete the problems by using skip counting. **The answer key shows the answers in the blank boxes below for your reference if needed.**

#1: Point to the barn. In the barn are 2 rows of horse stalls. There are 4 stalls in each row. How many stalls are there altogether?



#2: The farmer planted 5 rows of corn, and there are 7 corn plants in each row. How many corn plants are there altogether?



#3: Run your finger along all the fences you see in the painting. The farmer built 3 new sections of fences, and each section used 6 pieces of wood. How many pieces of wood did he use altogether?





"Leete Farm, West Claremont, New Hampshire" by Francis Alexander (1800–1880), c. 1822



# UNIT 4 OVERVIEW

## LESSONS 91-120

### Extra Supplies Needed

- ruler
- scissors
- plain or grid paper
- banana bread ingredients (optional for Lesson 118)

### New Concepts Taught

- Add and subtract measurements
- Bar graphs
- Compare and order measurements
- Congruency
- Construct geometric shapes
- Coordinate graphs
- Equivalent fractions
- Geometric transformations
- Lines, angles, and triangles
- Make change with money
- Median
- Mixed numbers
- Parts of a set
- Perimeter and area
- Pictographs
- Plot and interpret data
- Quadrilaterals
- Symmetry
- Tables
- Three-dimensional shapes
- Volume with tablespoons, teaspoons, and half teaspoons

### Parent/Teacher Tips

- The concept of multiplication is introduced in Math 2. Multiplication fact memorization is introduced in Math 3. However, many children in Math 2 like using Musical Multiplication (available on [goodandbeautiful.com](http://goodandbeautiful.com)) to start memorizing multiplication facts.
- Now that you have done so many lessons, consider changing things up by letting the child use erasable colored pens or by having the child choose a sticker to put on each completed lesson.
- If the child can still use help increasing speed with basic addition facts, consider playing a game before or after each lesson. Have the child roll two 10-sided dice and add them together, saying the sum aloud. Then you do the same. The person who rolls the larger sum gets a tally mark for getting the larger score. Play as quickly as you can for 5 to 7 minutes.

#### Painting Credits for Page 267

1. "The Herding Girl's Resting Time" by Alfred Wahlberg (1834-1906), c. 1875-1878
2. "Girl with Two Rabbits" by Felix Schlesinger (1833-1910), date unknown
3. "Bavarian Landscape" by Albert Bierstadt (1830-1902), date unknown
4. "Girl from Tangier" by Josep Tapiró Baró (1836-1913), c. 1900-1910
5. "Horses Balking at Approaching Storm" by Rudolf Koller (1828-1905), 1849
6. Adobe Stock Image
7. "Lunch" by Friedrich Proelss (1855-1934), 1900
8. "Deer in Sunny Forest Clearing" by Franz Xaver von Pausinger (1839-1915), 1880
9. "Puppies' Breakfast" by Walter Hunt (1861-1941), August 1885
10. "Ducks at the Pond" by Carl Jutz (1838-1916), 1899
11. "Happy Summer Day at Marxzell" by Hans Thoma (1839-1924), 1915
12. "View of the Untersberg in Berchtesgadener Land" by Heinrich Brandes (1803-1868), date unknown
13. "The Little Knitters" by Albert Anker (1831-1910), c. 1850-1900
14. "Autumn at Lake Starnberg" by Karl Adam Heinisch (1847-1923), date unknown

# TALLY CHARTS AND PICTOGRAPHS

## Money

Take the bills from the math box, and give the child several bills in a mixed-up pile (such as 2 \$100 bills, 6 \$20 bills, 4 \$10 bills, 6 \$5 bills, and 3 \$1 bills). Have the child sort the money into like bills and count the bills. (Start with the highest-value bills.) Repeat with different piles of bills several times.

- **Read to the child:** Todd and his grandmother are going to the art museum where his grandmother's painting is being shown. She has given him a challenge to see how many paintings he can find that feature people, nature, and animals. He takes a notebook to write down his data. **Data** is information collected. Todd makes a **tally chart** to organize his data. Filling in a chart with marks that represent numbers is faster than writing out words or numbers.

When reading a chart, start by reading the title, the categories, and the symbols. **Have the child find and point out these parts on the graph.** Count the tally marks and write the number of paintings Todd saw in each category.

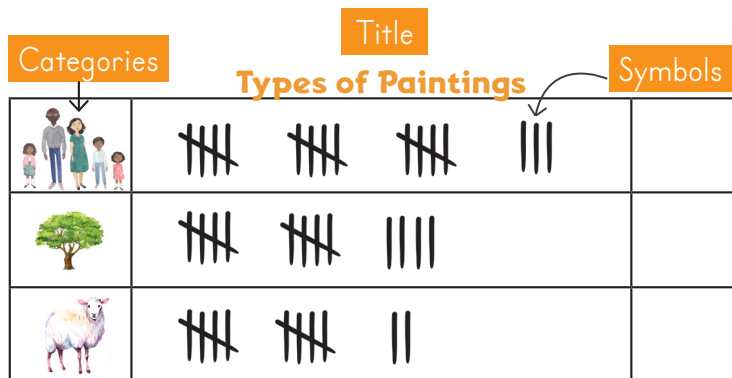

- **Read to the child:** Todd created a pictograph of his data below. A **pictograph** is a graph that uses pictures to display data. A pictograph also includes a **key** that tells you the number represented by the picture or symbol. **Have the child find and point to the symbol and key below.** The key tells us that each paintbrush symbol represents 2 paintings. Count the paintbrushes by 2s and write the total for each row in the blue boxes.

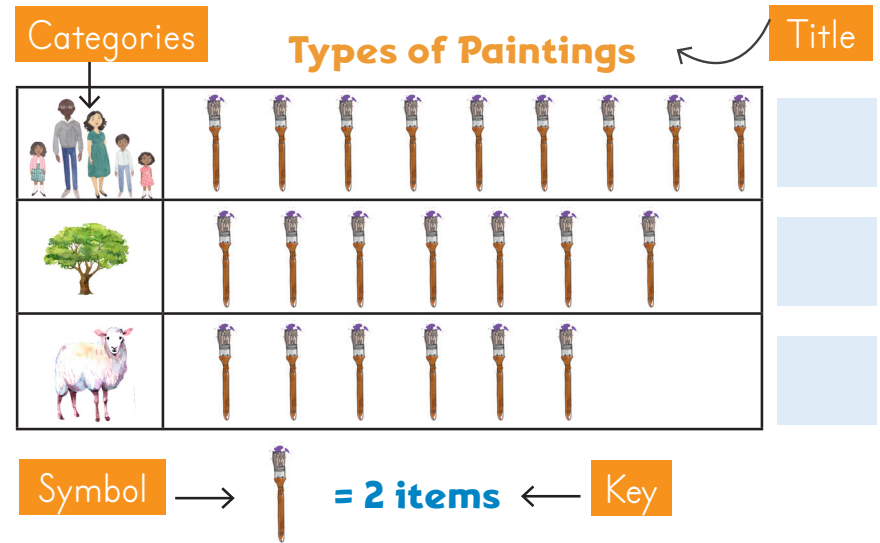

- **Take out a piece of scratch paper. Read to the child:** We are going to make a tally chart using the art gallery on the next page. Draw a chart on your scratch paper with three rows and three columns, just like the tally chart to the left. Next, write a title. For the categories write "people," "nature," and "animals." In each row draw tally marks to represent the number of paintings for each category. How many paintings do you see of each kind? Which category has the most paintings?
- **Where Is Grandmother's Painting? Activity.** **Read to the child:** Each numbered painting corresponds to a numbered subtraction problem at the bottom of the page. Complete each problem. The problem that has an answer of 50 is Grandmother's painting.







1



2



3



4



5



6



7



9



11



10



8



12



13



14

1	2	3	4	5	6	7	8	9	10	11	12	13	14
9	10	74	44	84	13	88	80	8	76	36	90	7	63
- 5	- 9	- 28	- 15	- 34	- 7	- 22	- 10	- 3	- 39	- 15	- 25	- 2	- 37



Write the correct number in each box.

# INDEPENDENT REVIEW

100 less

10 less

4,623

10 more

100 more

100 less

10 less

2,578

10 more

100 more

For each amount shown, circle the bills and coins you would use to equal the amount. (Hint: Circle the highest-value bills and coins you can use first.)

\$31.16



\$75.85



Thousands 	Hundreds 	Tens 	Ones 
---------------	--------------	----------	----------

In the orange chart, write the number shown by the base-10 blocks.

Thousands	Hundreds	Tens	Ones

Write the number of days in each month. If needed, reference the poem on page 152.

October

November

December



Lesson  
**94**

**FINDING THE MEDIAN**

Skip Counting

Have the child skip count backward by 3s from 21 to 3.

Fractions

Play the "Fraction Dice Game." (Instructions are on page 145.)

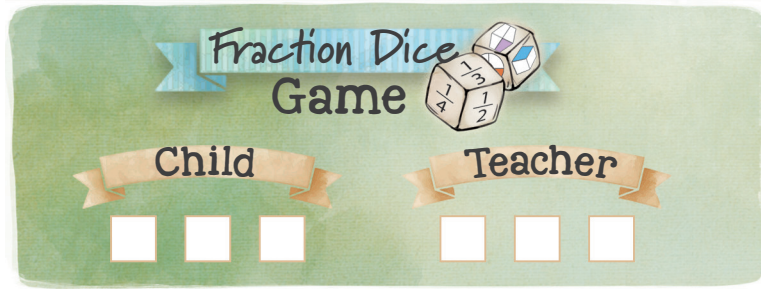

- **Read to the child:** Use the tables to fill in the blue boxes from least to greatest, and then circle the median number.

Bike Ride	# of miles
Tuesday	3
Thursday	5
Saturday	4

Bike Ride	# of miles
Monday	7
Tuesday	2
Wednesday	3

Bike Ride	# of miles
Thursday	8
Friday	4
Saturday	1

- **Read to the child:** Today, we are going to learn how to find the **median**. The median is the number in the middle of a list of numbers when the numbers are in order from least to greatest. The table to the right shows the number of miles the Garcia family went on a bike ride. Tell me what days they biked and how many miles they went each day. We are going to use this data to find the median. The boxes below show the numbers from the table sorted from least to greatest. The middle number is circled; this is the median.

Bike Ride	# of miles
Monday	2
Wednesday	1
Friday	6

1

2

6



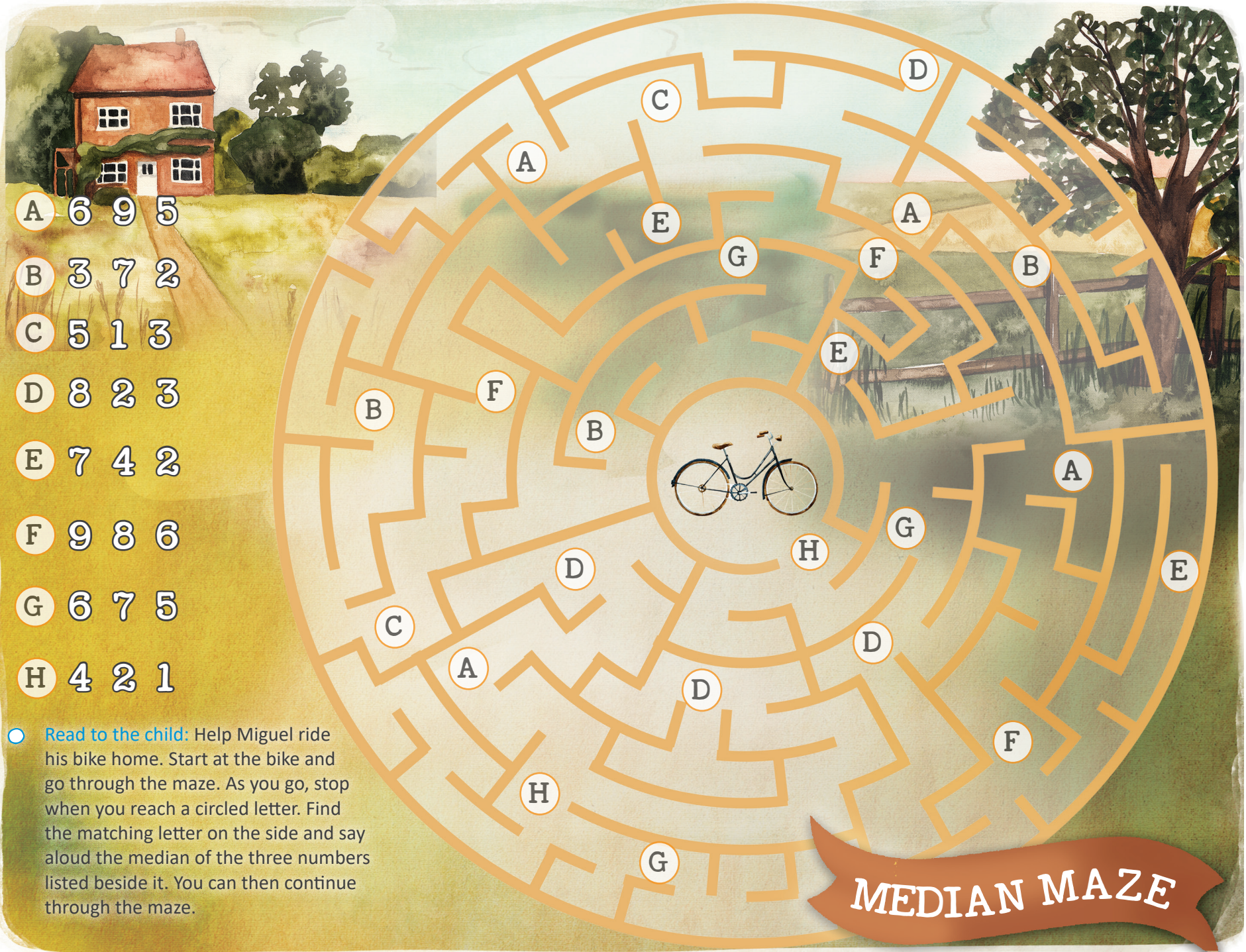

A 6 9 5

B 3 7 2

C 5 1 3

D 8 2 3

E 7 4 2

F 9 8 6

G 6 7 5

H 4 2 1

● **Read to the child:** Help Miguel ride his bike home. Start at the bike and go through the maze. As you go, stop when you reach a circled letter. Find the matching letter on the side and say aloud the median of the three numbers listed beside it. You can then continue through the maze.

# MEDIAN MAZE



## IDENTIFYING PARTS OF A SET

### Skip Counting

Have the child skip count by 4s from 4 to 28 once or twice. If needed, have the child use the chart.

1	2	3	4	5	6	7	8	9	10
11	12	13	14	15	16	17	18	19	20
21	22	23	24	25	26	27	28	29	30

### Mental Math

Have the child add 100 to each number.

$$500 + 100 \quad 3,000 + 100 \quad 5,100 + 100$$

- **Read to the child:** Look at the group or set of circles below. There are 6 total circles, and 3 of the 6 are blue. The blue circles represent a part of the whole set. Look at the fraction to the right of the set. Point to the 6 representing how many are in the whole set. Point to the 3 representing the part of the set that is shaded.

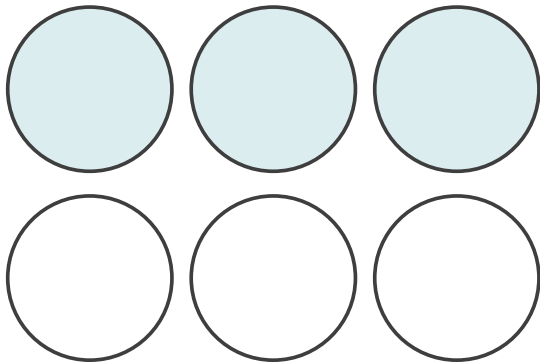

**PART**

$$\frac{3}{6}$$

**WHOLE**

- **Read to the child:** For each group of airplanes below, circle the correct fraction for the specified set.

**RED**



$$\frac{3}{6}$$

$$\frac{4}{5}$$

$$\frac{2}{5}$$

**LARGE**

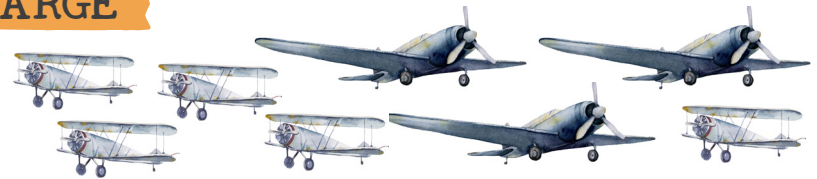

$$\frac{3}{8}$$

$$\frac{4}{8}$$

$$\frac{3}{5}$$

**SMALL**

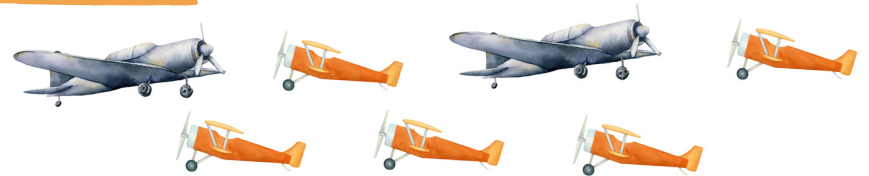

$$\frac{5}{8}$$

$$\frac{5}{7}$$

$$\frac{2}{5}$$

- **Above the Clouds Game:** Take an airplane from the math box. Read to the child: Place an airplane on "START." Look at the group of purple and blue birds near your plane. Write how many birds are in the whole set under the fraction line. Then write the part specified in the box above the fraction line. Fly your plane clockwise in a circle and do the same for the other four groups.

START

BLUE

WHITE

ABOVE  
THE

CLOUDS

RED

DARK

SPOTTED

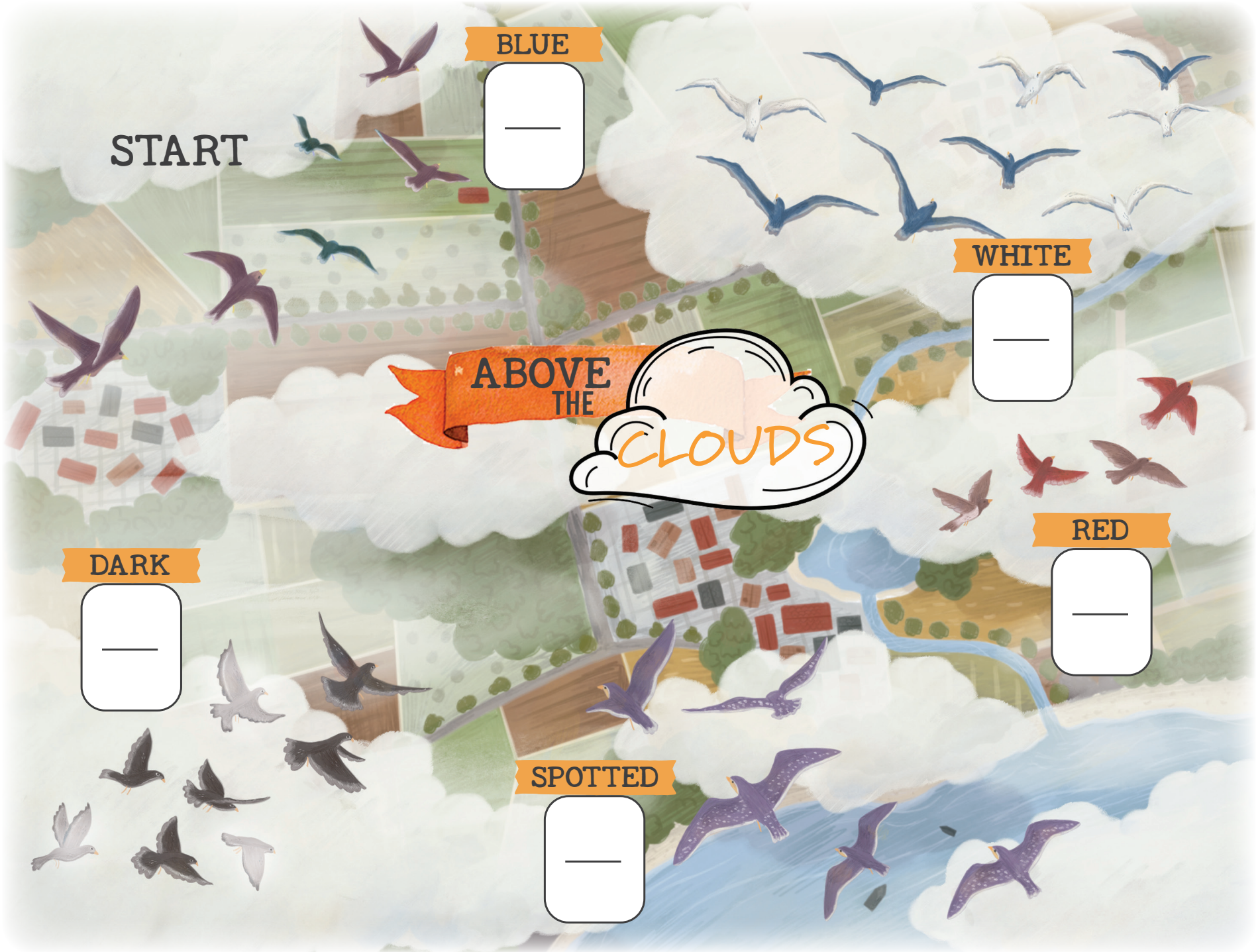



# Hidden Numbers

Six numbers are hidden in this picture. Color the objects that contain the numbers. In the blank boxes on the left, write the number word for each hidden number.

Complete the problems.

\_\_\_\_\_

-----

\_\_\_\_\_

\_\_\_\_\_

-----

\_\_\_\_\_

\_\_\_\_\_

-----

\_\_\_\_\_

\_\_\_\_\_

-----

\_\_\_\_\_

\_\_\_\_\_

-----

\_\_\_\_\_

\_\_\_\_\_

-----

\_\_\_\_\_



$160 - 10 =$

$1,389 - 1 =$

$135 - 10 =$

$1,422 - 1 =$

$267 - 10 =$

$2,000 - 1 =$

$3,000 - 1 =$

## GEOMETRIC SOLIDS

## Money

Take the bills from the math box, and give the child several bills in a mixed-up pile (such as 2 \$100 bills, 6 \$20 bills, 4 \$10 bills, 6 \$5 bills, and 3 \$1 bills). Have the child sort the money into like bills and count the bills. (Start with the highest-value bills.) Repeat with different piles of bills several times.

- **Read to the child:** *Three-dimensional* shapes are shapes that are solid and not flat. We often refer to them as 3D shapes. The shapes below are examples of three-dimensional shapes. Point to each shape and say its name.

## Some Examples of 3D Shapes

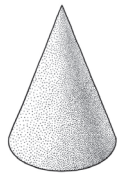

Cone

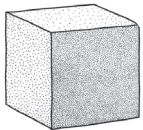

Cube

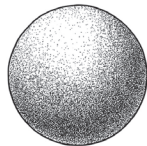

Sphere

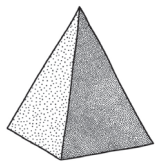

Pyramid

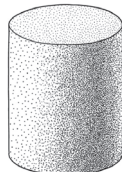

Cylinder

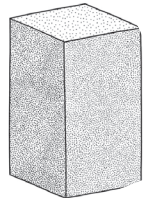

Rectangular Prism

A two-dimensional, flat shape, such as a square, is often defined by the number of sides or lines making up the shape. A face is a flat surface on a solid. A square pyramid has four triangular faces and one square face on the bottom. How many faces does a cube have? [6] How many faces does a cylinder have? [2] A cone only has one face—the circle at the bottom. A sphere does not have any faces.

- **Read to the child:** Find and point to the following shapes on the sandcastle below.

Cone

Pyramid

Cylinder

Cube

Rectangular Prism



- **Read to the child:** Find the hidden geometric shapes in the picture on the next page. Write the grid coordinates for their locations (for example, A4).

CONE

CUBE

SPHERE

PYRAMID

CYLINDER

RECTANGULAR PRISM



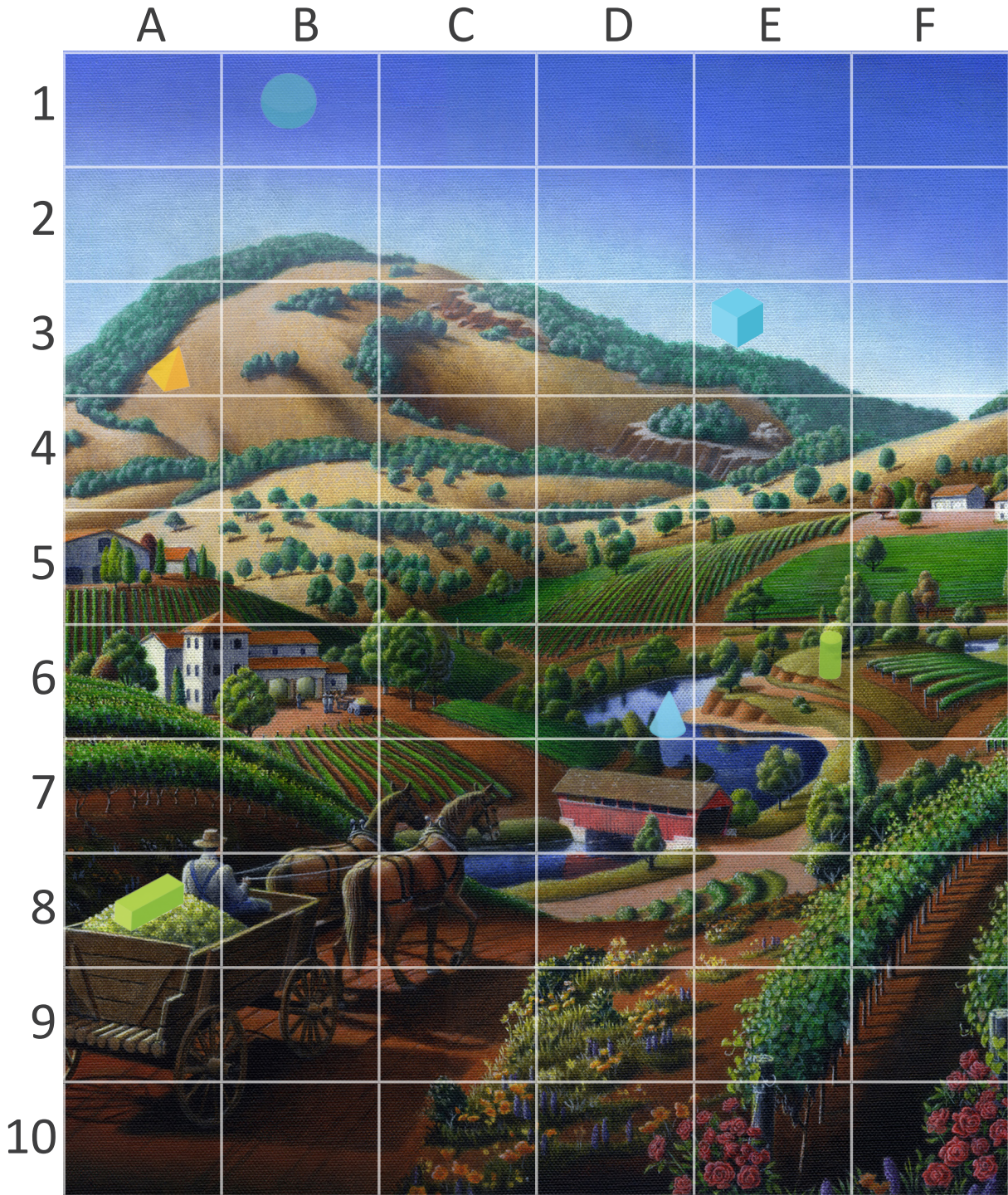

... INDEPENDENT REVIEW ...

Write the addition problem and multiplication problem shown by each array.

Addition Problem:

Multiplication Problem:

$\times \times \times \times$   
 $\times \times \times \times$   
 $\times \times \times \times$

Addition Problem:

Multiplication Problem:

$\times \times \times \times \times \times \times \times \times$   
 $\times \times \times \times \times \times \times \times \times$   
 $\times \times \times \times \times \times \times \times \times$

With Xs, show an array that represents the addition and multiplication problems.

Addition Problem:  $5 + 5 + 5$

Multiplication Problem:  $3 \times 5$

"Wine Country Landscape" by Walt Curlee, 2015



Lesson  
**115**

**AREA: PART 2**



**Skip Counting**

Have the child skip count backward by 3s from 21 to 3.

**Fractions**

Play the "Fraction Dice Game." (Instructions are on page 145.)

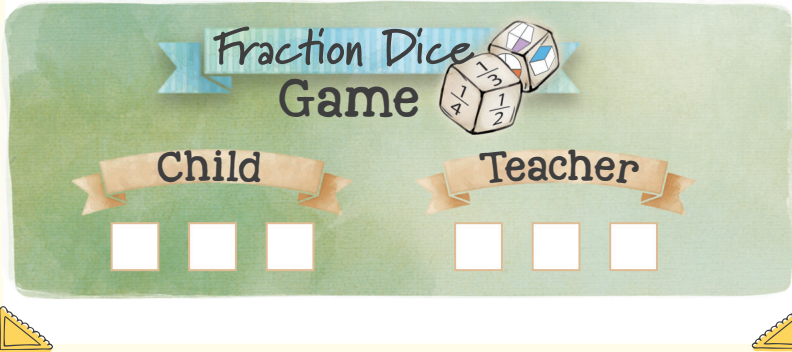

○ **Read to the child:** We are going to skip count to find the area of the rectangles on the robots. The number of blue boxes represents the number of columns. Write the number of square units in each column in each blue box, and then skip count to find the answer. Write it in the orange box.

①  $\square + \square + \square = \square$

②  $\square + \square = \square$

③  $\square + \square + \square + \square = \square$

④  $\square + \square + \square + \square = \square$

○ **Read to the child:** You learned from the last lesson that area is the space inside a 2D shape. Find the area of this rectangle by counting the square units. [12]

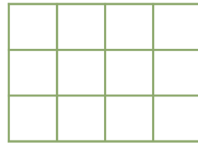

Counting each square unit is one way to find area, but there is a quicker way. The square units below show the columns (vertical stacks of square units) of the rectangle above pulled apart. We can now easily see that each of the four columns has three boxes. Skip count by 3s

$3 + 3 + 3 + 3$  to find the area.



How many times did you add 3 together? Yes, 4 times. You added 3s (for the number in each column) four times (for the number of columns).

Look at the orange rectangle. How many square units are in each column? [2] How many columns are there? [4] Skip count by 2s four times to find the area of this rectangle.

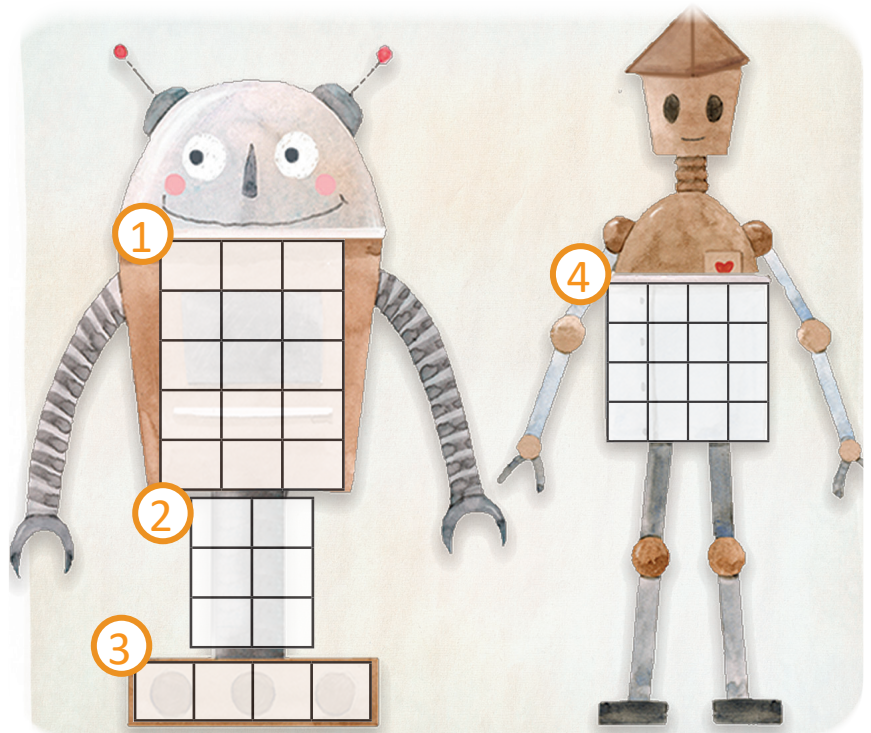
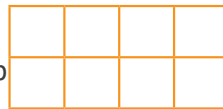



- **Read to the child:** Find the area of each blue shape on the robot by using the same steps as before. On scratch paper, write the number of square units in each column and skip count by the number of columns.

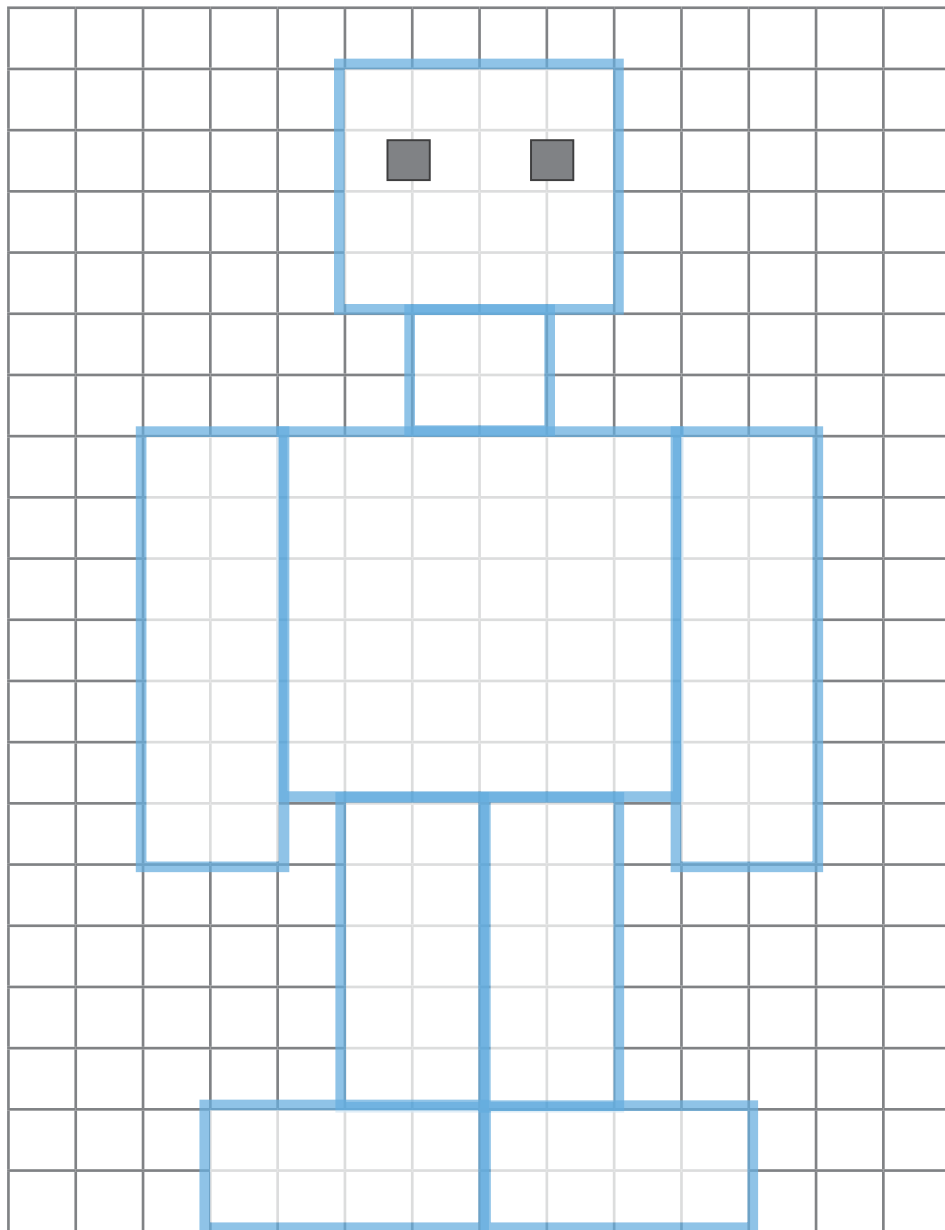

- **Optional Activity.** Using grid or plain paper, have the child create his or her own robot and find the area of each square or rectangle on the robot.

## INDEPENDENT REVIEW

Fill in the circle that shows the most reasonable weight of each item.

1 ounce is about the weight of a pencil.

1 pound = 16 ounces | 1 ton = 2,000 pounds

Flower



- 3 tons
- 8 pounds
- less than one ounce

Passenger Airplane



- 15 ounces
- 40 pounds
- 350 tons

Camera



- 1 ton
- 60 pounds
- 14 ounces

Backpack with Books



- 5 pounds
- 150 tons
- 20 ounces

Fill in the circle that shows the most reasonable weight of each item.

1 gram is about the weight of a paper clip.

1 kilogram = 1,000 grams (about the weight of a pineapple)

Chair



- 2 kilograms
- 3 grams
- 50 kilograms

Bottle of Glue



- 50 kilograms
- 100 kilograms
- 110 grams

Truck



- 2,700 kilograms
- 17 kilograms
- 6 grams

Leaf



- 1 gram
- 1½ kilograms
- 40 grams